

tech  rack
tech tray™



WORKPIECE CARRIERS & CLEANING RACKS FOR INDUSTRY

FLEXIBLE, SAFE and EFFICIENT

CONTENTS

Advantages

FRIES workpiece carriers and cleaning racks at a glance

Page 3 - 13



tech-rack variogrid

Page 14 - 25



techtray

Page 26 - 37



tech-rack custom⁺

Page 40 - 47



tech-rack custom

Page 48 - 59



tech-rack

Page 60 - 73



Workpiece carrier systems All the advantages at a glance
www.fries-kt.com

With us, innovation is a system

"Workpiece carriers and cleaning racks - flexible, all-in-one systems for industry - impressive results in logistics, cleaning and storage."

Component cleaning is a central element of many production and assembly processes in sensitive industries such as metal processing, optics, medical technology, mechatronics, micro-electronics or precision engineering. Parts-specific workpiece carriers and cleaning racks are used here. These hold the workpieces in a specific position and at specific points in order to achieve the best possible cleaning result.

FRIES workpiece carriers

tech-rack variogrid – THE FLEXIBLE SOLUTION

Secure positioning of highly complex parts



techtray – THE VERSATILE SOLUTION

In a standard rack / compartment rack or as an independent workpiece carrier



FRIES cleaning racks

tech-rack custom+ – THE VARIABLE SOLUTION

Specially designed for use in automated production processes



NEW

tech-rack custom – INDUSTRY 4.0

Developed for automated production processes



tech-rack – THE ADAPTABLE SOLUTION

Variable height adjustment, can be adjusted for use with other compartment dimensions



All-in-one systems for industry

» Gentle transport

» Secure storage

» Flawless cleaning

All consistently in one system



CLEANING



TRANSPORTING



STORING

The advantages of workpiece carriers and cleaning racks

"Perfect solutions for your requirements"

Alongside the specific product benefits, which are set out in detail from page 14 onwards, all FRIES workpiece carriers and cleaning racks that have been developed especially for the cleaning, transport and storage of sensitive components boast the following advantages:



Plastic instead of stainless steel

- » Optimised protection against impact spots and scratches on the components
- » Fewer rejects



Plastic satisfies tough demands

- » For rigorous thermal and chemical requirements in conventional industrial parts cleaning operations
- » Ideal for water-based processes and processes that use solvents, as well as for ultrasound applications
- » No migration of the plastic



Cost savings thanks to optimised process workflows

- » All in one: less repackaging of components – from production and cleaning to storage and assembly, as well as transport



Workpiece carrier systems All the advantages at a glance

www.fries-kt.com

Other advantages of the FRIES systems

» **A range of customised configuration options**

Modular system, easily converts to other component geometries, stackable.

» **Optimised protection and safety**

No clamping or fastening of components required – contact is only with plastic; no pressure points and no scratches on components, resulting in fewer rejects.

» **Efficient cleaning with optimised accessibility**

Optimised openings and rounded edges on the system help achieve superlative component cleaning and excellent drying – no need to move cleaning agents around either. Thanks to the rounded edges, water drains effectively and no separate cleaning of the empty containers is required.

» **Low weight**

Workpiece carriers and cleaning racks made from plastic are lighter than comparable metal racks and metal plates.

» **Automation-friendly**

Saves wage and personnel costs.

» **Reusable system**

Reusable workpiece carriers and cleaning racks replace the previous disposable blister packaging. This conserves valuable resources and helps protect the environment.

» **Easy and safe to use**

Reduced risk of injury thanks to rounded edges, easy identification thanks to logistically trackable labelling, zero-tool assembly.

Plastic, the proven alternative to metal

FRIES materials in detail:

COMP 13/14 material

FRIES Comp 13/14 was designed for basic needs in industrial component cleaning and is suitable for cleaning processes using aqueous or solvent-based media as well as for ultrasound applications.

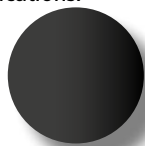

COMP 21/22 material

FRIES Comp 21/22 offers even higher chemical and thermal resistance and is therefore suitable for more exacting demands in industrial parts cleaning. It can be used in autoclaves for steam sterilisation, for example.

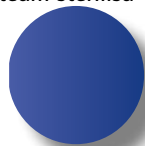

COMP 25 (ESD) material

FRIES Comp 25 protects sensitive electronic components from electrostatic discharge. The generation of electrostatic charge is prevented and any charge that has already built up is dissipated in a controlled manner.



The range at a glance

"Workpiece carriers and cleaning racks for industrial component cleaning"

With the FRIES tech-rack models, sensitive and high-quality components can be safely and easily cleaned, stored and transported – all in just one rack, without having to be repacked. Increased effectiveness and cost efficiency – and therefore competitive advantages – can thus be leveraged.

tech-rack variogrid workpiece carrier

"Tailored to your requirements"

Basic dimensions 600 x 400 mm – can be adapted to specific dimensions

Materials according to requirement (see page 5):



Comp 13/14

Comp 21/22

Comp 25 (ESD)

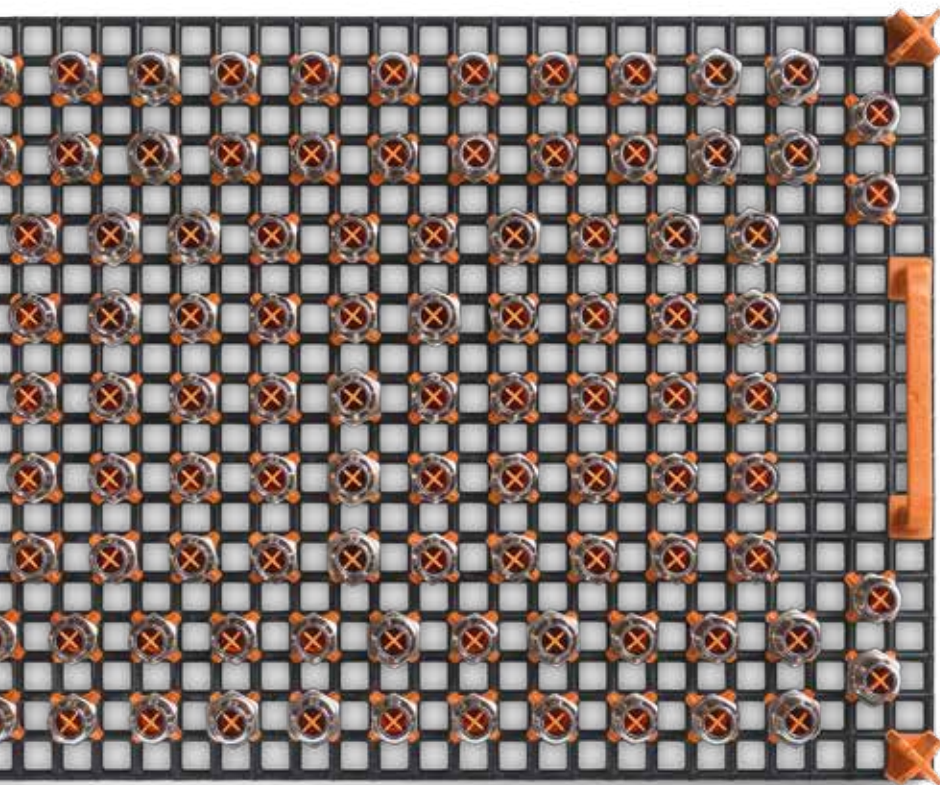

Advantages

- » Variable plate size: the plate can be cut to the desired size
- » Optimised use of space and extensive protection of the components (9-mm grid)
- » Suitable for complete automation
- » For better use of space, the handles can be attached in a modular fashion
- » ESD-compatible (with the same workpiece carrier in the ESD zones for assembly)
- » Dividers integrated into the base counteract the capillary effect

techtray workpiece carrier

"Offers a wide range of possible uses"

425 x 276 mm – Schäfer 2 format,

Materials according to requirement (see page 5):



Comp 13/14

Comp 21/22

Comp 25 (ESD)

Advantages

- » Base plate in "Schäfer 2 format"
- » Optimised use of space and extensive protection of the components (9-mm grid)
- » Suitable for complete automation
- » Recessed grips on the plate (no additional loss of space)
- » Can be combined with the tech-rack variogrid
- » ESD-compatible (with the same workpiece carrier in the ESD zones for assembly)
- » Dividers integrated into the base counteract the capillary effect

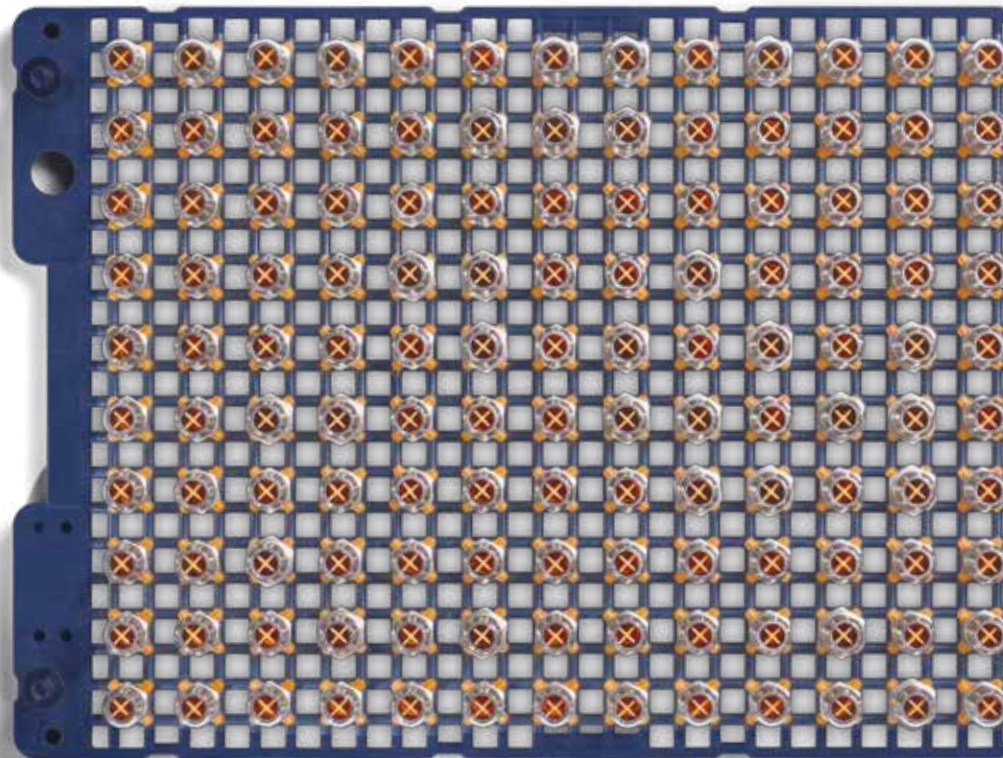

tech-rack custom⁺ cleaning rack

"Versatile use for automated handling"

400 x 300 mm – available with standard variogrid base or with customised grid base

Material (see page 5):



Comp 21/22

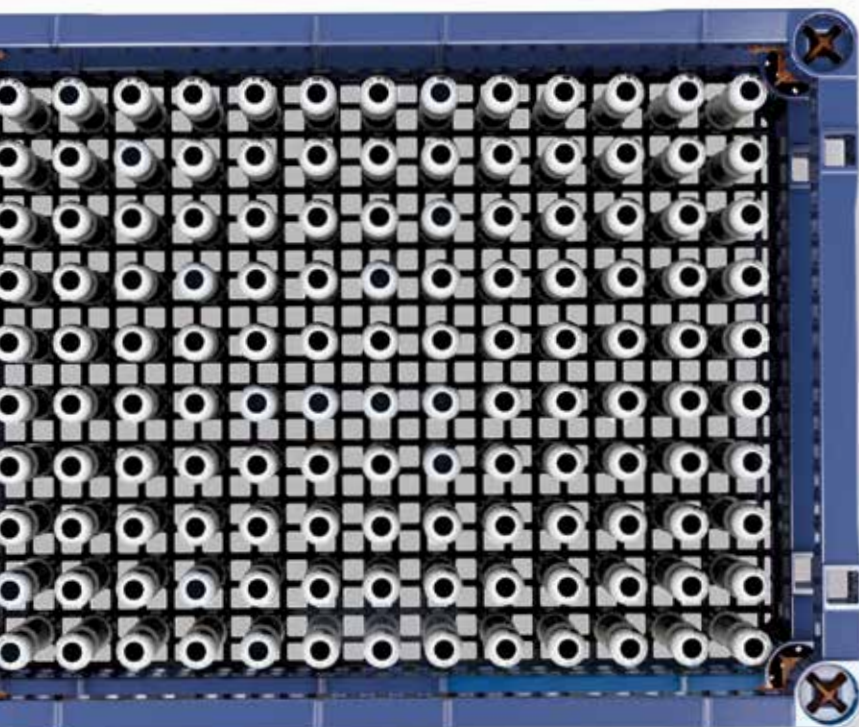

Advantages

- » Designed for complete automation
- » Component-related grid base available (components can be positioned without any pins or dividers)
- » Automated loading, unloading and stacking thanks to gripper arms
- » Angled stacking edge and dividers integrated into the base counteract the capillary effect
- » Optionally available with recessed grips
- » High load capacity
- » RFID chip available on request
- » Rounded corners offer protection against damage

tech-rack custom cleaning rack

"The right rack for complete automation and robot handling"

600 x 400 mm – available with standard variogrid base or with customised grid base

Material (see page 5):



Comp 21/22

Advantages

- » Designed for complete automation
- » Component-related grid base available (components can be positioned without any pins or dividers)
- » Automated loading, unloading and stacking thanks to gripper arms
- » Angled stacking edge and dividers integrated into the base counteract the capillary effect
- » High load capacity
- » RFID chip available on request
- » Rounded corners offer protection against damage

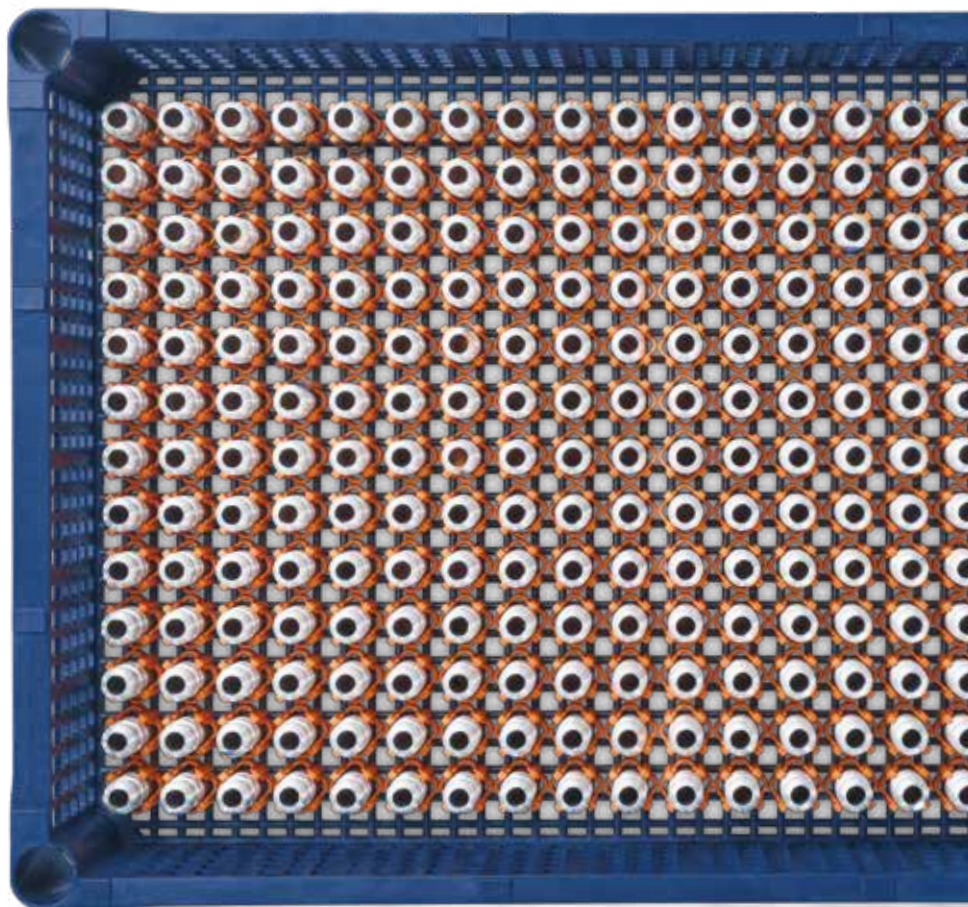

tech-rack cleaning rack

"The adaptable all-rounder"

600 x 400 mm – modular structure

Materials according to requirement (see page 5):



Comp 13/14

Comp 21/22

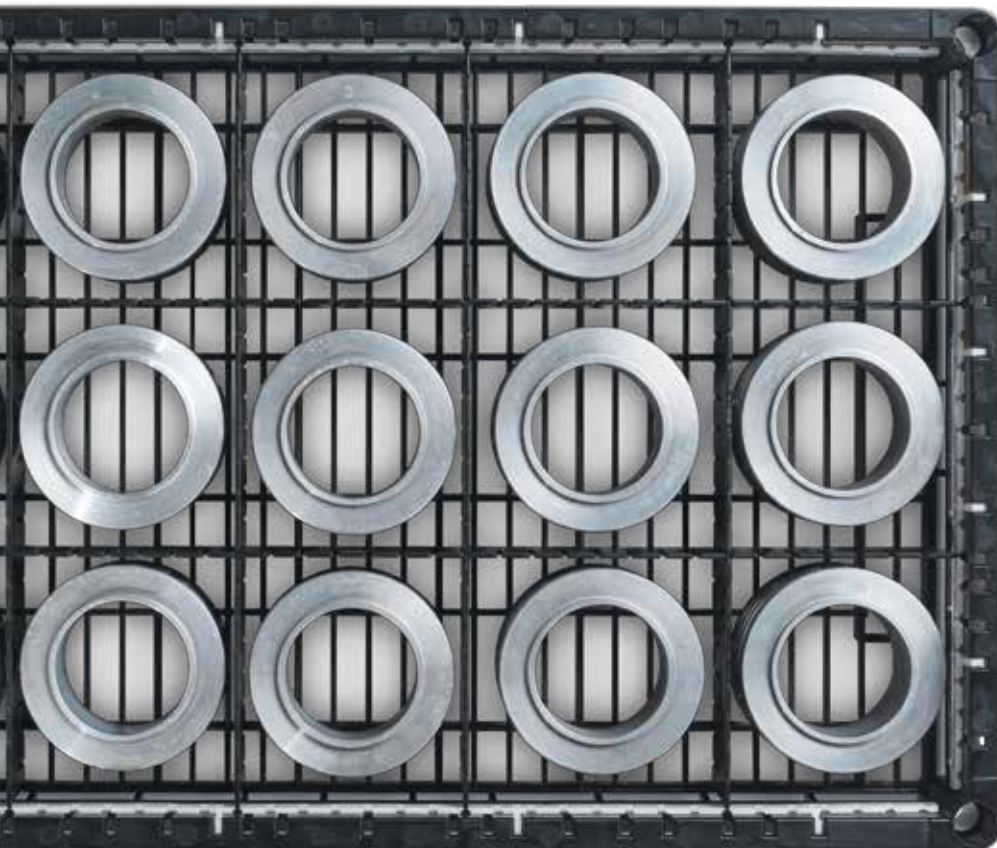

Advantages

- » Modular structure: adapts to the component geometry
- » Millimetre-accurate height adjustment
- » Optimised use of space and extensive protection of the components (15-mm grid)
- » High load capacity
- » Safety: openings in the cleaning rack can be sealed individually with intelligent side walls
- » Pallet-ready dimensions for both EURO pallets and other stacking systems (small load carrier (KLT) boxes, Euro stacking containers, etc.)

Rotary pin variety

"Numerous pins available"

For the precise positioning of components.
Customer-specific configurations are possible.



Comprehensive process chain in industrial component production

"Example of a possible production process"

In all areas of industrial component production, there are numerous process steps that a raw part goes through until it becomes the finished product. In between these individual steps, the workpiece needs to be constantly cleaned of contamination.

Such contamination might take the form of filings, oils or greases (particulate contamination), or glues, solders or welds (film-like contamination on the surface). If the fine particles and contamination are not removed, the downstream production steps will be interrupted and the component's function can become impaired or destroyed.

Clean is the dream: one rack for all process steps!

FRIES workpiece carriers and cleaning racks offer ideal process optimisation for industrial component production. The components are kept protected and clean as they move from process to process in one and the same rack. They therefore do not need to be repackaged manually or via automated means, which means individual packaging can be dispensed with as well. This saves a tremendous amount of time and money while at the same time offering maximum component protection. The workpieces, as well as the workpiece carriers and cleaning racks, are clean and protected in every phase of the process.

BLANK

SEPARATING

CLEANING

CLEANING

HONING

DRILLING

CLEANING

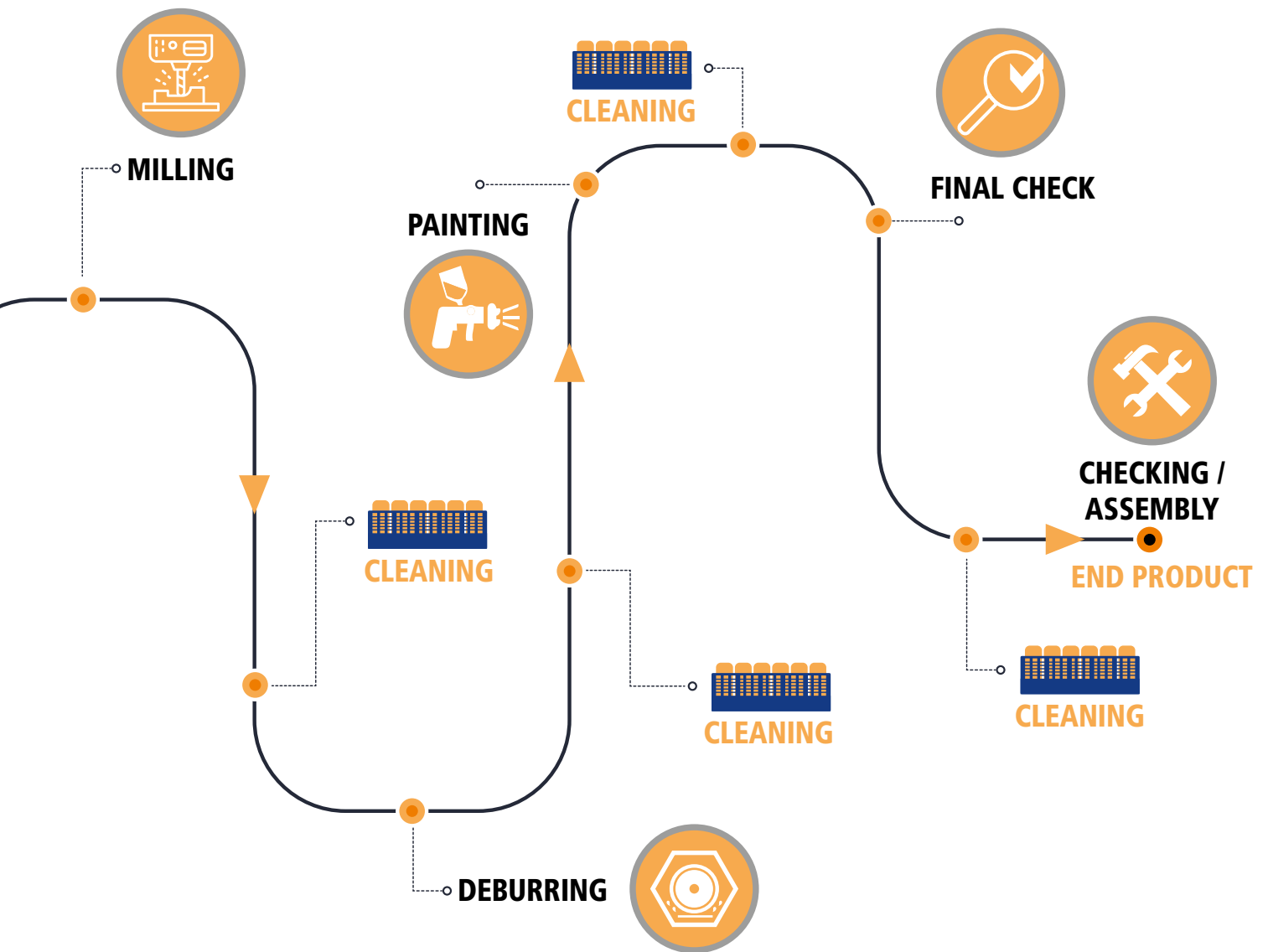

Industry 4.0 – networked production

"tech-rack custom cleaning rack"

Production logistics are changing: intelligent machinery, storage systems and operating materials are being linked with IT systems and are communicating with one other. They are doing this along the entire value chain – from warehousing and production through to logistics.

Automation and the use of robots therefore put even more demands on cleaning racks and workpiece carriers when it comes to cleaning, transport and storage. FRIES Kunststofftechnik has developed a cleaning rack that is ideal for automated production processes.



4. Automated palleting of the cleaning racks

3. Automated cleaning
in the cleaning system



2. Automated loading of the workpieces
in the cleaning racks



1. Automated handling of the
cleaning racks

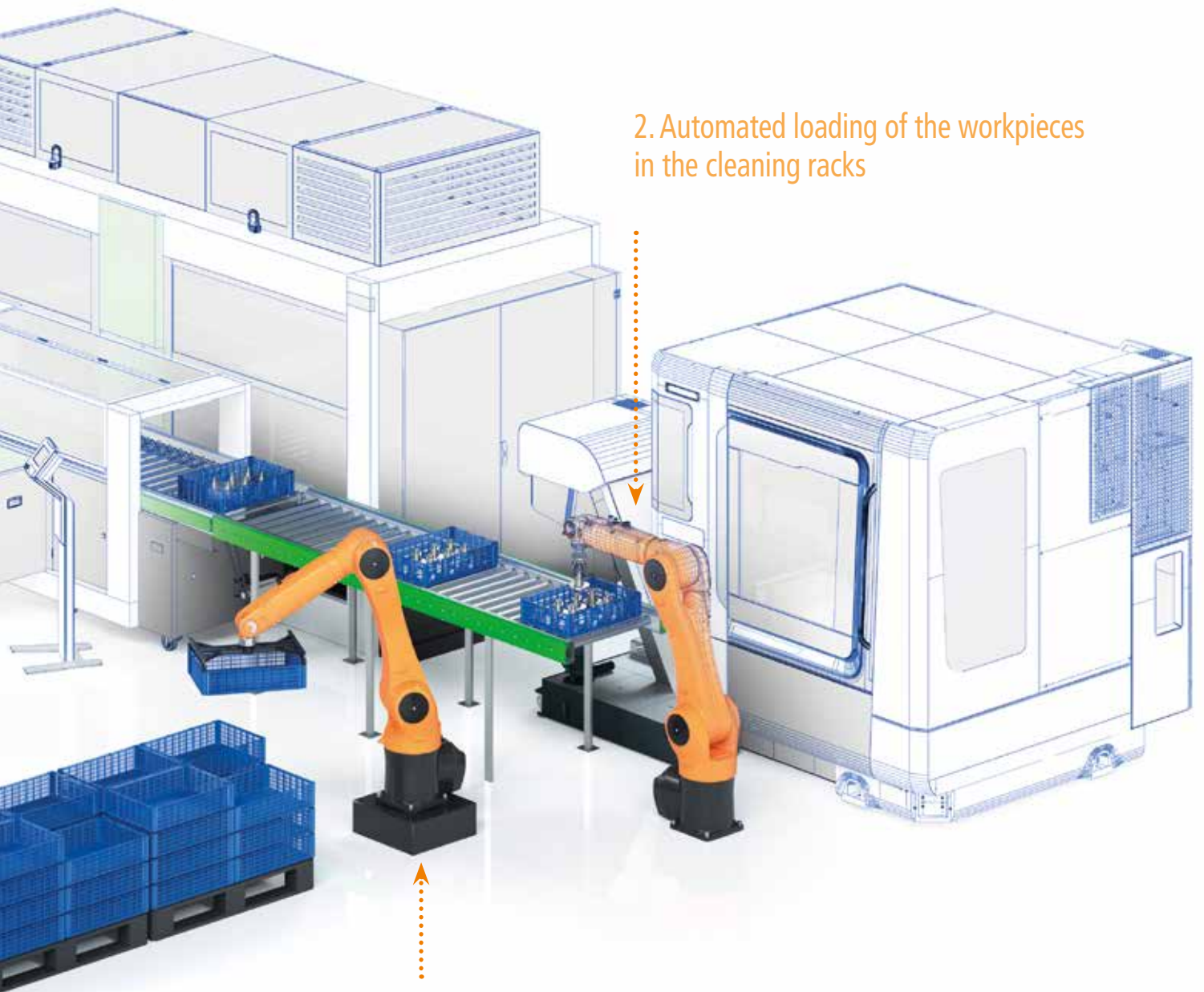

TECH-RACK VARIOGRID WORKPIECE CARRIER 600 X 400

THE FLEXIBLE SOLUTION for the secure positioning of highly complex small parts

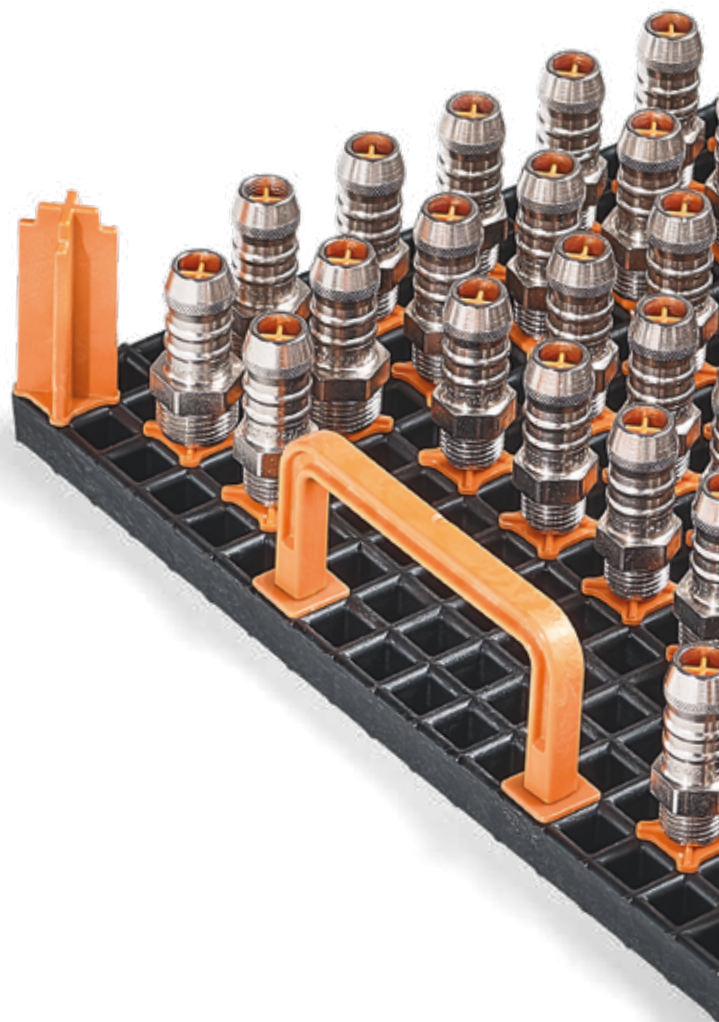

tech-rack variogrid workpiece carrier

"tech-rack variogrid – flexible, all-in-one systems for industry.
The flexible workpiece carriers from FRIES for logistics, cleaning and storage."

The tech-rack variogrid workpiece carriers offer a high degree of efficiency and a significant reduction in costs with regard to the logistics and cleaning of sensitive metal parts. The workpiece carrier plates can be custom-sized and therefore adapted to the conditions inside the cleaning machine, and also adapted for storage in small load carriers (KLTs). To ensure stackability in every size, the rotating stacking bolts can be positioned anywhere on the grid plate. This means that sensitive and high-quality components can be safely and easily cleaned, stored and transported – all in just one workpiece carrier, without any need for repositioning or repacking.

Materials depending on requirements: (see page 5)



Comp 13/14



Comp 21/22



Comp 25

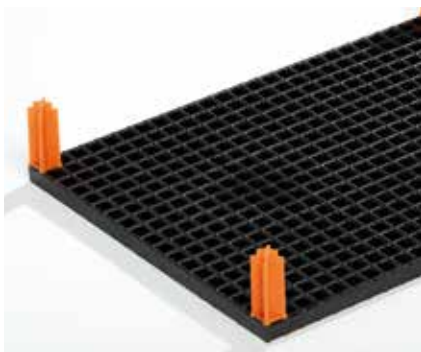

Variable plate size

The tech-rack variogrid plate can be customised to the desired size and process conditions. The workpiece carriers can be easily stacked thanks to the rotating stacking bolts.

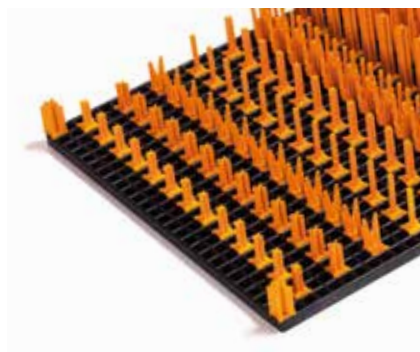

Optimised surface and scratch protection

The variogrid plate, with its modular structure, allows rotary and plug-in pins to be attached flexibly without any tools. The components are positioned precisely and securely and are protected against impact points and scratches.



Fast and flexible compartment adaptation with dividers

The variogrid plate can be adjusted on the longitudinal and lateral side in a 9-mm grid. Component dividers are available in heights of 28, 42, 69 and 96 mm. The components are perfectly protected in the compartments.

Application examples

Numerous rotating and plug-in pins

Numerous rotating and plug-in pins for shafts, sleeves, turned parts, milled parts, etc. are available for the precise positioning of components on the variogrid base plate. Rotating pins can also be custom-produced on request to suit individual components.



A variety of fastening options

The tech-rack variogrid press-fit bases support a variety of fastening options. This means that threads, screws, hooks or even handles can be mounted on the base plate with zero effort.

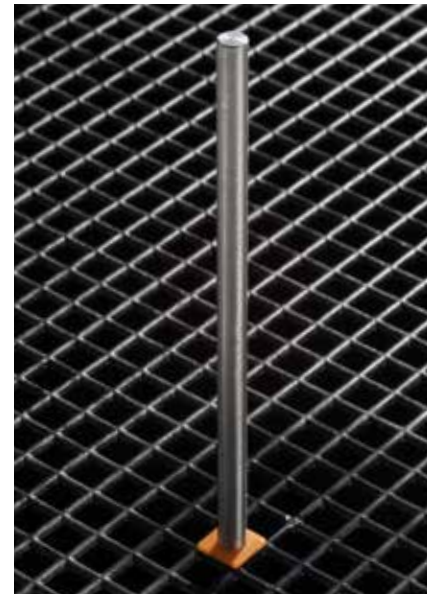
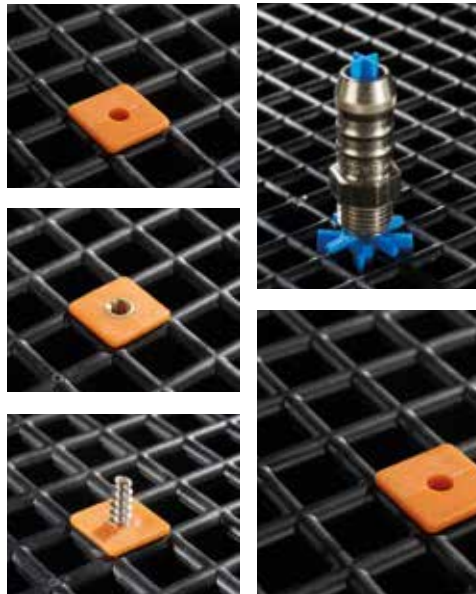

Maximum variability & flexibility

The variogrid rotating stacking bolts and rotating pins can be attached to the base plate wherever they are required and also subsequently rearranged. This means that stackability is guaranteed, regardless of the plate size.

Easy assembly



1. Plug in

2. Rotate

3. Ready to load or stack

Other advantages

- » Suitable for complete automation and robot handling
- » Simple and fast assembly
- » Handles can be attached in a modular manner, allowing maximum use to be made of the space on the workpiece plate
- » The dividers are slotted into the base, counteracting the capillary effect
- » ESD-compatible (with the same workpiece carrier in the ESD zones for assembly)
- » A wealth of different configuration options ensures maximum possibilities for component holding

References

HAAG-STREIT AG Koeniz (CH)

The leading manufacturer of slit lamps relies on the tech-rack variogrid workpiece carrier throughout the entire production process, from the lathe to assembly. The workpiece carriers are loaded on the lathe and cleaned in the chamber system. The emphasis is on maximum particulate and surface cleanliness. The workpiece carriers are then conveyed in Euro boxes to the assembly area.



SENSOR COMPANY (CH)

This sensor technology producer uses the tech-rack variogrid workpiece carrier in areas ranging from the turning and milling centre to storage facilities. Unique identification ensures that the workpiece carrier is inserted with the right compartment dividers in the magazine. This is important because the turning and milling centre produces components overnight on an automated basis, thanks to 48 different workpiece carriers that are loaded by the robot.





Haag-Streit AG, Koeniz (CH)

Stefan Oetliker



"With the tech-rack variogrid, we are able to prevent component damage (impact points and scratches). We also save on process costs thanks to simplified handling."



FRENCKEN MECHATRONICS B.V. Eindhoven (NL)

Frencken designs, develops and produces individual components for its clients, but also complete machines and systems for the medical industry and the research sector. Its clients include companies such as ASML, Philips Medical Systems, Bruker and Thermo Fisher Scientific. Companies that develop and manufacture products for the high-tech sector also need to satisfy extreme cleaning requirements. Frencken uses the latest system technology, which incorporates the tech-rack variogrid system. The flexible workpiece carrier ensures an optimised cleaning result, offers superlative protection for sensitive surfaces and enables components to be transported without being damaged.

The system components: Comp 13/14 material

The Comp 13/14 material was designed for basic needs in industrial component cleaning and is suitable for cleaning processes involving aqueous and solvent-based media, as well as for ultrasound applications.

tech-rack variogrid workpiece carrier plate

Basic dimensions 600 x 400 mm, height 13 mm
The plate can be custom-cut to size.
(see page 24)



Low top frame

600 x 400 mm, height 36 mm,
can be combined with the tech-rack
variogrid and tech-rack cleaning racks



Tall top frame

600 x 400 mm, height 63 mm,
can be combined with the tech-rack
variogrid and tech-rack cleaning racks



Application example: variogrid base plate with
frame, allows combination with tech-rack racks



Dividers

Each adapted to the relevant plate size, allowing for
compartments that fit the size of the workpieces
Available in heights of 28, 42, 69 and 96 mm



Lengths: 272 mm / 376 mm / 558 mm

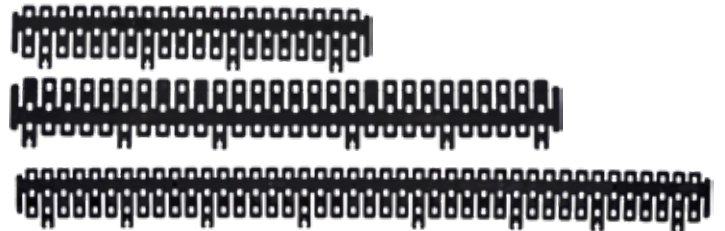

Lengths: 272 mm / 376 mm / 558 mm

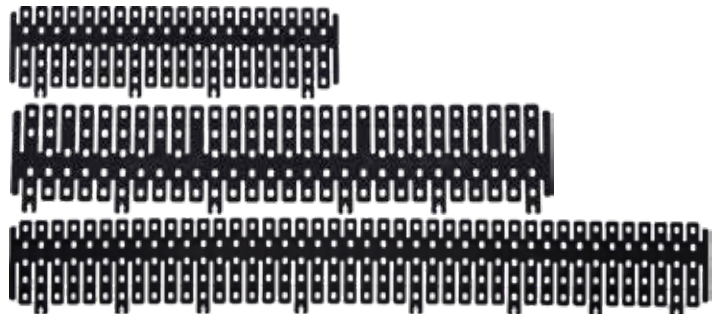

Lengths: 272 mm / 376 mm / 558 mm

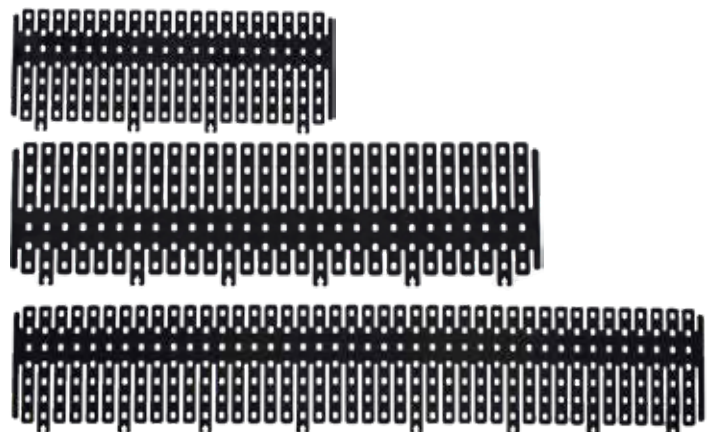

Lengths: 272 mm / 376 mm / 558 mm

The system components: Comp 21/22 material

The Comp 21/22 material offers even higher chemical and thermal resistance and is therefore suitable for more exacting demands in industrial parts cleaning.

tech-rack variogrid workpiece carrier plate

Basic dimensions 600 x 400 mm, height 13 mm
The plate can be custom-cut to size.
(see page 24)



Low top frame

600 x 400 mm, height 36 mm,
can be combined with the tech-rack
variogrid and tech-rack cleaning racks



Tall top frame

600 x 400 mm, height 63 mm,
can be combined with the tech-rack
variogrid and tech-rack cleaning racks



Application example: variogrid base plate with
frame, allows combination with tech-rack racks



Dividers

Each adapted to the relevant plate size, allowing for
compartments that fit the size of the workpieces
Available in heights of 28, 42, 69 and 96 mm



Lengths: 272 mm / 376 mm / 558 mm



Lengths: 272 mm / 376 mm / 558 mm

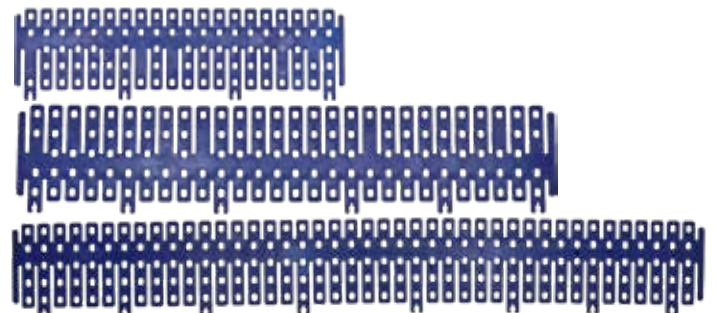

Lengths: 272 mm / 376 mm / 558 mm

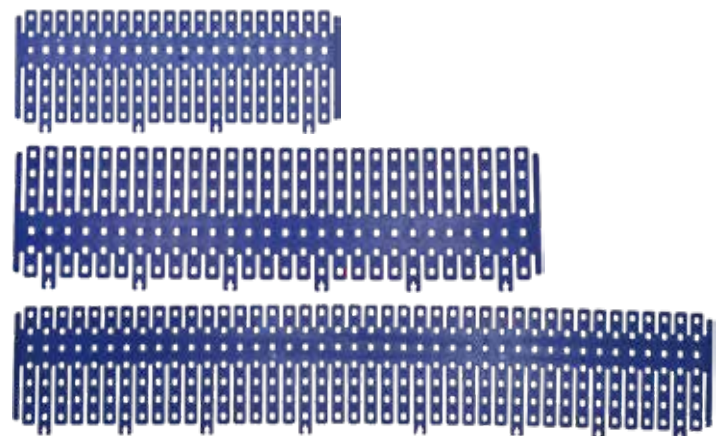

Lengths: 272 mm / 376 mm / 558 mm



ESD – conductive workpiece carriers

The system components: Comp 25 (ESD) material

The Comp 25 material protects sensitive electronic components from electrostatic discharge. The generation of electrostatic charge is prevented and any charge that has already built up is dissipated in a controlled manner.

tech-rack variogrid workpiece carrier plate

Basic dimensions 600 x 400 mm, height 13 mm
The plate can be custom-cut to size.
(see page 24)



Low top frame

600 x 400 mm, height 36 mm,
Can be combined with the tech-rack variogrid and tech-rack cleaning racks



Tall top frame

600 x 400 mm, height 63 mm,
Can be combined with the tech-rack variogrid and tech-rack cleaning racks



Dividers

Each adapted to the relevant plate size, allowing for compartments that fit the size of the workpieces
Available in heights of 28, 42, 69 and 96 mm

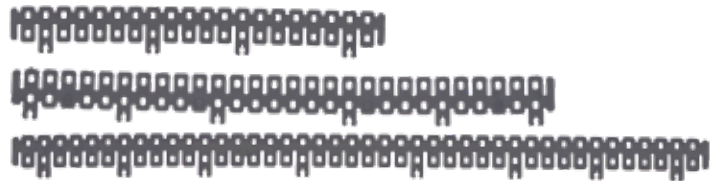

Lengths: 272 mm / 376 mm / 558 mm

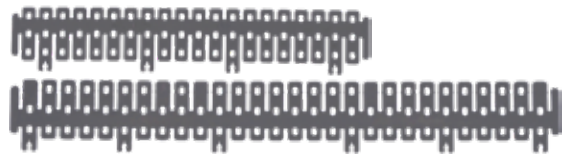

Lengths: 272 mm / 376 mm / 558 mm

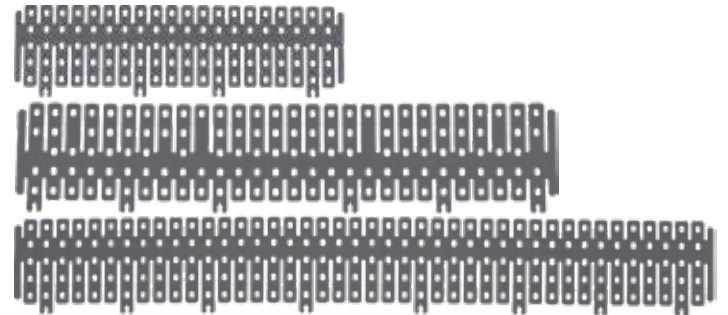

Lengths: 272 mm / 376 mm / 558 mm

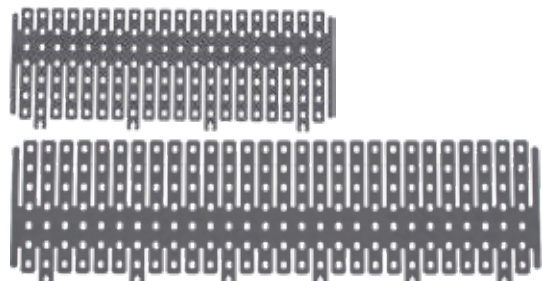

Lengths: 272 mm / 376 mm / 558 mm

The system components: Accessories

Rotating stacking bolts

The rotating stacking bolts can be positioned anywhere on the base plate to ensure stackability in every size.

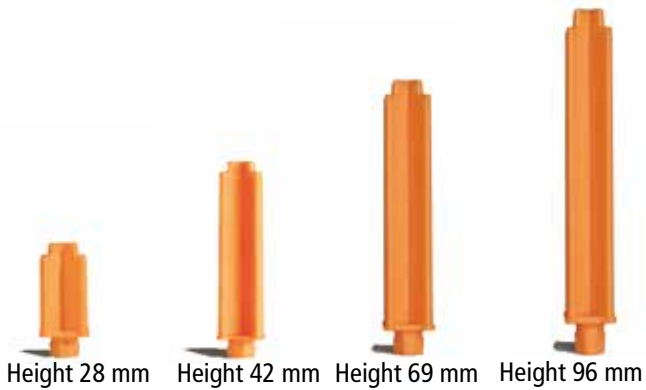

ESD rotating stacking bolts

The ESD rotating stacking bolts can be positioned anywhere on the base plate to ensure stackability in every size.



Handles

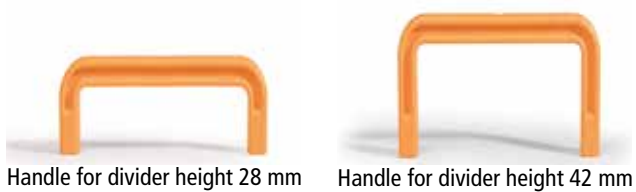

Press-fit bases

The press-fit bases can be driven into the tech-rack variogrid base plate. This allows a variety of fastening options for hooks, bolts, handles and much more.

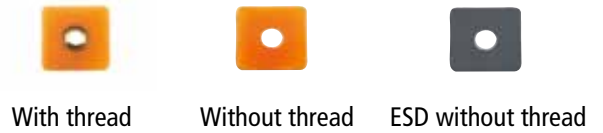

1. Hammering



2. Ready for further assembly

ESD handles



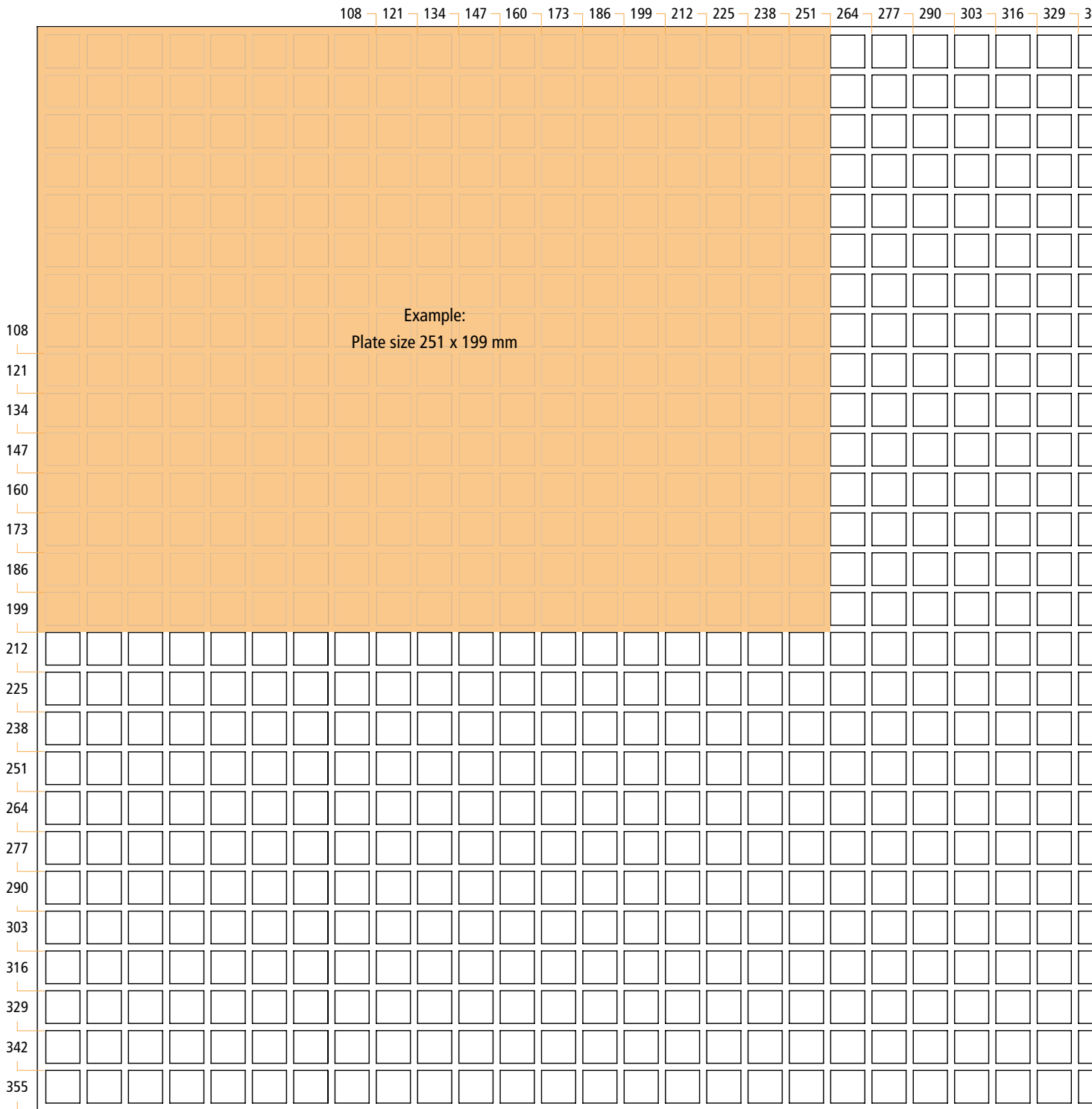

Dimensions in mm, tolerance +/- 1.5 mm

TECHTRAY WORKPIECE CARRIER 425 X 276

THE VERSATILE SOLUTION in the standard rack / compartment
rack or as an independent workpiece carrier

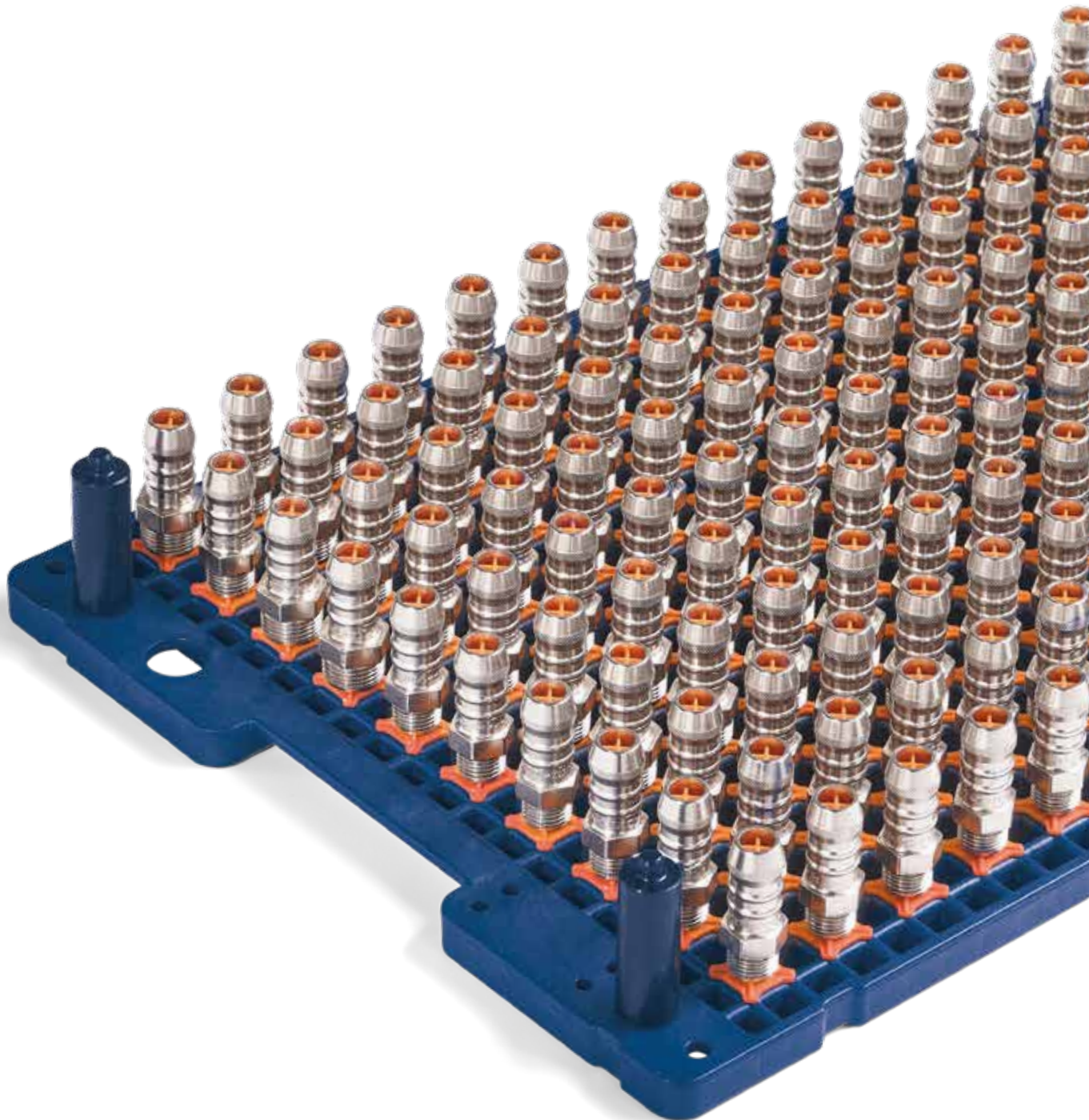

techtray workpiece carrier

"techtray – complete component protection and flexibility.
The impressive workpiece carriers from FRIES for logistics, cleaning and storage."

techtray is a modular workpiece carrier that ensures greater safety and efficiency in industrial component cleaning and in-house production logistics. To achieve optimised cleaning results in highly sensitive areas such as metal processing, optics, medical technology, mechatronics, micro-electronics or precision engineering, techtray combines the advantages of plastic workpiece carriers with the shape of a metal grid rack base.

The fixing of the workpieces in a specific position and at specific points avoids damage and scratches and the optimised rinsing during the cleaning process makes techtray the definitive standard in industrial parts cleaning, parts handling and parts logistics.

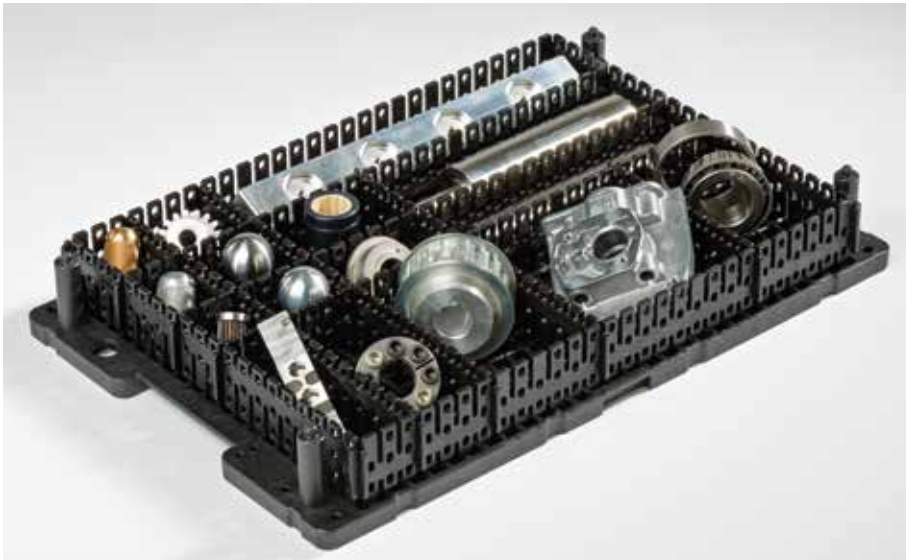

Materials depending on requirements: (see page 5)



Comp 13/14



Comp 21/22



Comp 25



Base plate in Schäfer 2 format

The techtray plate is adapted to the most common Schäfer 2 devices in cleaning systems and transport boxes. techtray can be used both in a standard rack or a compartment rack and as an independent workpiece carrier as well.



Precise positioning for optimised component protection

Rotating and plug-in pins can be attached flexibly and easily on the techtray plate without tools via a plug-in system. The components are positioned precisely and are protected against impact points and scratches.



Flexible and easy compartment adjustment with dividers

With dividers, a grid of 9 mm can be created. These dividers are available in four heights. Bases and compartment dividers have sufficient openings for even and effective rinsing & drying.

Application examples



Application example: techtray stacked 2-high



Application example: techtray stacked 3-high with cover



Application example: techtray stacked 2-high in a compartment rack with cover



Application example: techtray stacked 3-high with a compartment rack with hold-down frame

Numerous rotating and plug-in pins

Numerous rotating and plug-in pins for shafts, sleeves, turned parts, milled parts, etc. are available for the precise positioning of components on the techtray plate. Customised models are available on request.



Stackable at various heights

With the stacking bolts, multiple techtray plates can be stacked at will on top of each other. Four different standard heights are available. On request, stacking heights can be supplied with millimetre accuracy.



A variety of fastening options

The press-fit bases support a variety of fastening options. This means that threads, screws, hooks or even handles can be mounted on the base plate with zero effort.

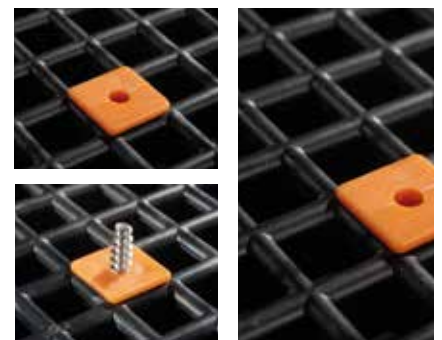

Other advantages

- » Suitable for complete automation and robot handling
- » Recessed grips on the plate for better use of space
- » Multi-tray function (base=cover)
- » Stackable thanks to stacking bolts; therefore offers various heights
- » Can be combined with the tech-rack variogrid
- » The dividers are slotted into the base, counteracting the capillary effect
- » ESD-compatible (with the same workpiece carrier in the ESD zones for assembly)
- » Rounded edges allow optimised flow behaviour and reduce the risk of injury

References

COMVAT AG Haag (CH)

The techtray workpiece carrier is used for the entire production process from the lathe to storage as well as during assembly. The workpiece carriers are loaded at the lathe and then cleaned in a fully automatic ultrasonic cleaning system with 7 baths. Cleaning takes place in an ISO-8 clean room environment. The focus in this environment is film cleanliness and optical cleanliness (vacuum compatibility). The workpiece carriers are then stacked in Euro boxes for storage and further assembly.



SCHNEEBERGER AG Roggwil (CH)

The specialists in linear technology use the techtray workpiece carriers from the lathe to cleaning and final packaging. In addition to achieving a high standard of cleanliness, the workpieces are perfectly protected during the processes that occur throughout the entire plant. This reduces costs for intermediate packaging. The attached labels ensure that workpiece carriers with the correct compartment divisions are supplied to the workstations.





Comvat AG, Haag (CH)

Herbert Hager



"Efficiency and cleanliness throughout the entire production process is our focus. The tech-tray system provides us with the foundation for this."



Schneeberger AG, Roggwil (CH)

Marc Meier



"The workpiece carriers from FRIES are lightweight, flexible and safe to use in our processes. This saves us a tremendous amount of time and money, while at the same time ensuring superb cleanliness."

The system components: Comp 13/14 material

The Comp 13/14 material was designed for the basic needs of industrial component production and is suitable for cleaning processes involving aqueous and solvent-based media, as well as for ultrasound applications.

techtray workpiece carrier plate

425 x 276 mm

The workpiece carrier plate can be used both as a base and as a cover.

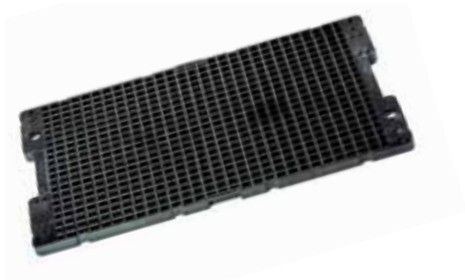

Dividers

Each adapted to the relevant plate size, allowing for compartments that fit the size of the workpieces
Available in heights of 28, 42, 69 and 96 mm



Lengths: 272 mm / 376 mm

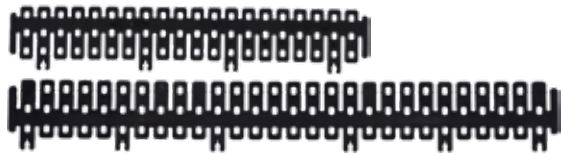

Lengths: 272 mm / 376 mm

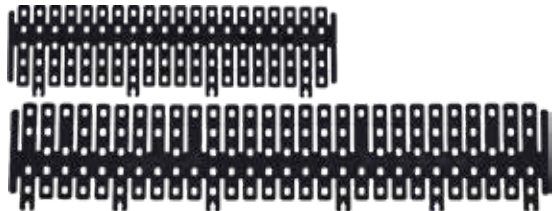

Lengths: 272 mm / 376 mm

Stacking bolts for techtray

The workpiece carrier plates can be stacked at various heights with the stacking bolts.



Height
28 mm

Height
42 mm

Height
69 mm

Height
96 mm

Customised heights are available on request!

Application example: techtray workpiece carrier plate can be stacked in the compartment rack

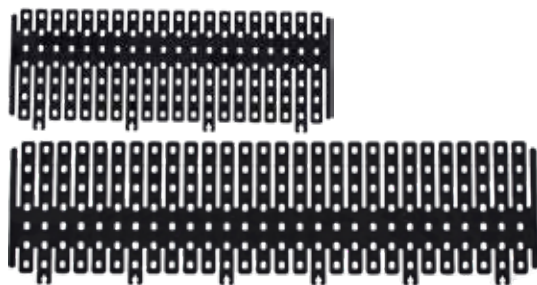

Lengths: 272 mm / 376 mm

The system components: Comp 21/22 material

The Comp 21/22 material offers even higher chemical and thermal resistance and is therefore suitable for more exacting demands in industrial parts cleaning

techtray workpiece carrier plate

425 x 276 mm

The workpiece carrier plate can be used both as a base and as a cover.



Dividers

Each adapted to the relevant plate size, allowing for compartments that fit the size of the workpieces
Available in heights of 28, 42, 69 and 96 mm



Lengths: 272 mm / 376 mm

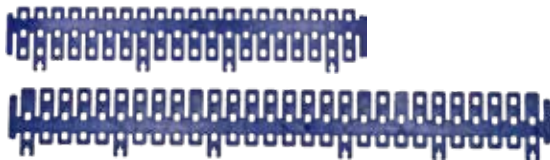

Lengths: 272 mm / 376 mm

Stacking bolts for techtray

The workpiece carrier plates can be stacked at various heights with the stacking bolts.



Height
28 mm

Height
42 mm

Height
69 mm

Height
96 mm

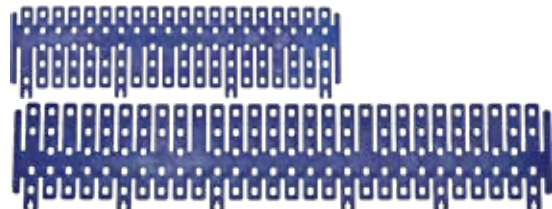

Lengths: 272 mm / 376 mm

Customised heights are available on request!

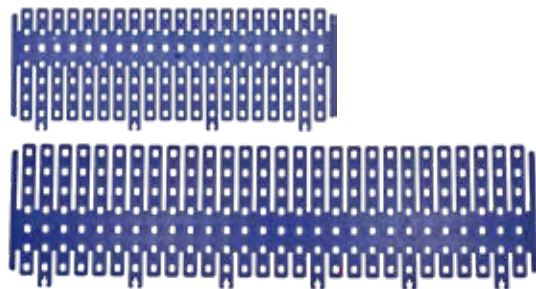

Lengths: 272 mm / 376 mm



ESD – conductive workpiece carriers

The system components: Comp 25 (ESD) material

The Comp 25 material protects sensitive electronic components from electrostatic discharge. The generation of electrostatic charge is prevented and any charge that has already built up is dissipated in a controlled manner.

techtray workpiece carrier plate

425 x 276 mm

The workpiece carrier plate can be used both as a base and as a cover.



Dividers

Each adapted to the relevant plate size, allowing for compartments that fit the size of the workpieces
Available in heights of 28, 42, 69 and 96 mm



Lengths: 272 mm / 376 mm

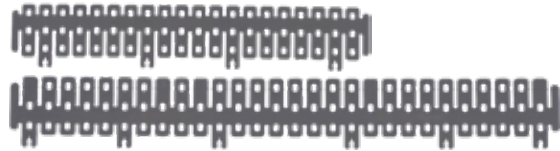

Lengths: 272 mm / 376 mm

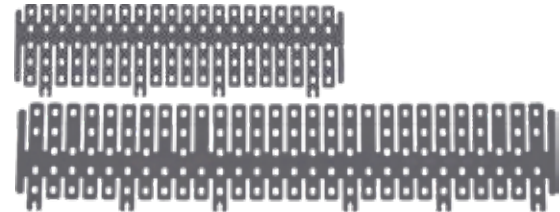

Lengths: 272 mm / 376 mm

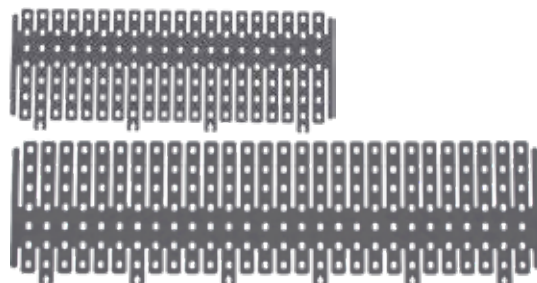

Lengths: 272 mm / 376 mm

The system components: Accessories

Rotating stacking bolts

The rotating stacking bolts can be positioned anywhere on the base plate to ensure stackability in every size.

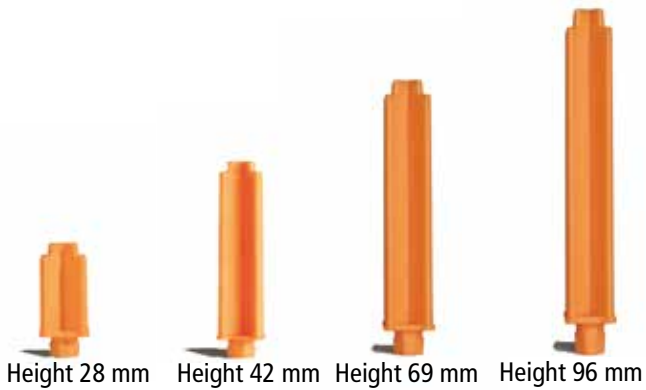

ESD rotating stacking bolts

The ESD rotating stacking bolts can be positioned anywhere on the base plate to ensure stackability in every size.



Handles



Press-fit bases

The press-fit bases can be driven into the techtray base plate. This allows a variety of fastening options for hooks, bolts, handles and much more.

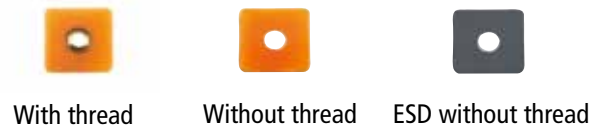

1. Hammering



2. Ready for further assembly

ESD handles



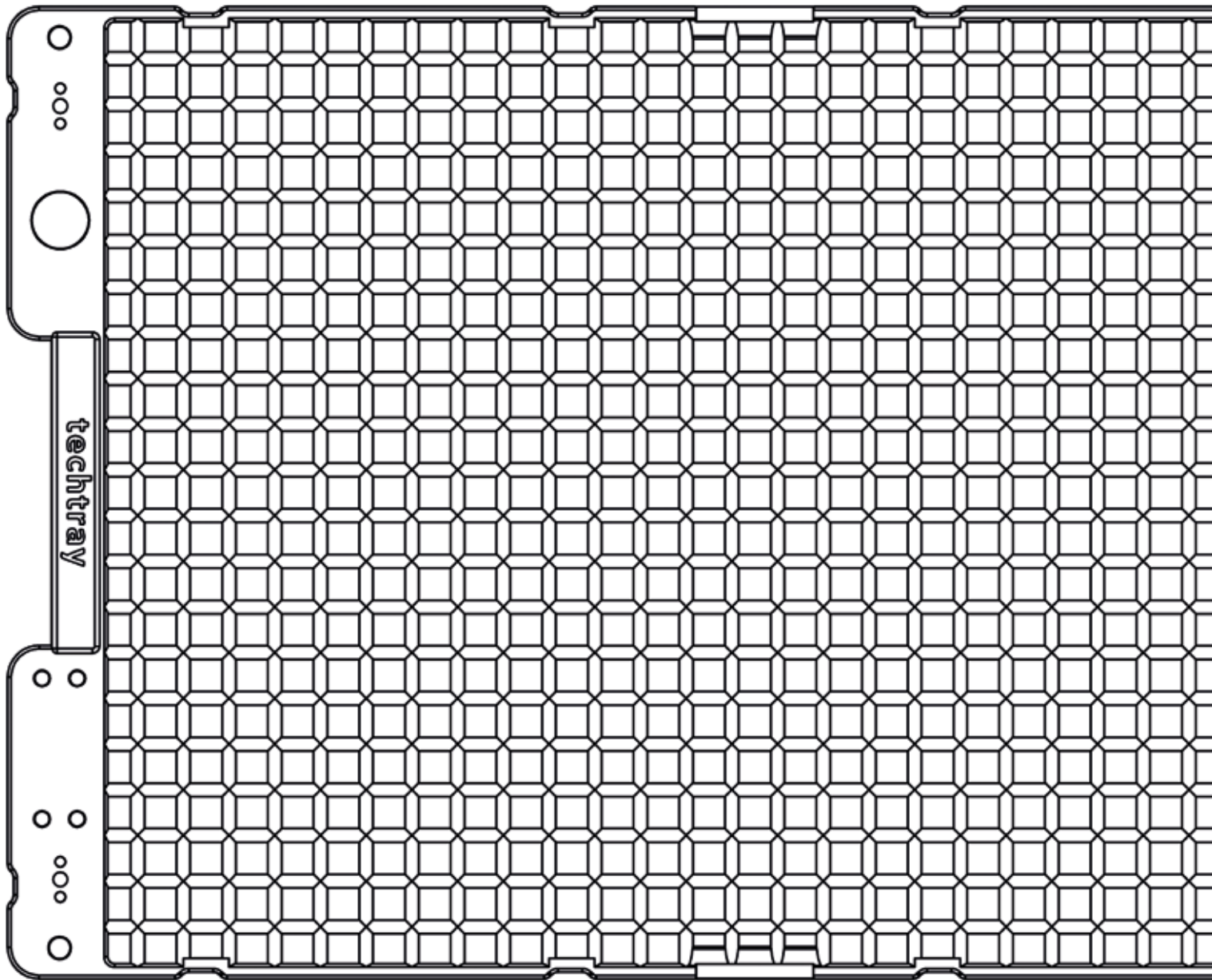

Flexible division

Universal compartments and plugging options mean that the techtray can be divided perfectly according to the particular requirements.

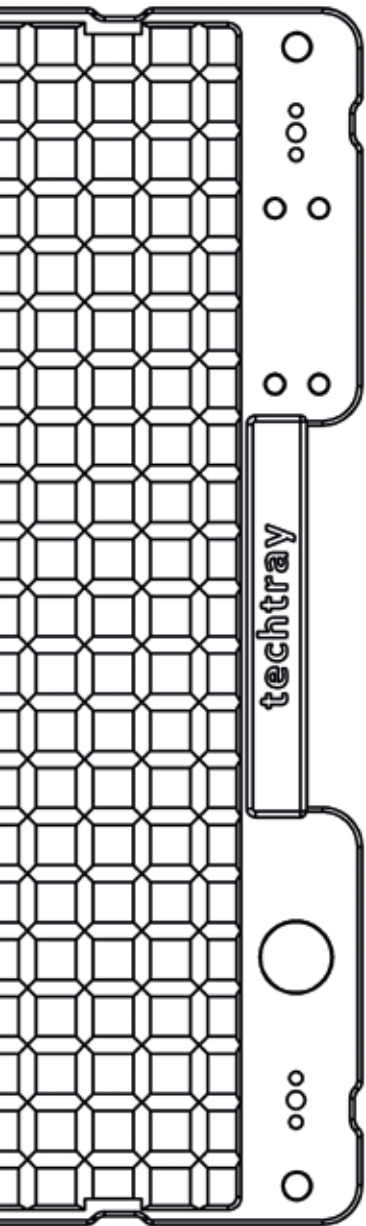

TECH-RACK CUSTOM⁺ CLEANING RACK 400 X 300

THE VARIABLE SOLUTION designed especially for use in automated production workflows

NEW



tech-rack custom⁺ cleaning rack

"tech-rack custom⁺ – ideal for automated production in industry.
The powerful cleaning rack from FRIES for logistics, cleaning and storage."

The tech-rack custom⁺ cleaning rack was developed especially for the new requirements of fully automated production. It allows the thorough and gentle cleaning of high-quality metal parts or sensitive workpieces. Angled stacking edges and studs prevent the capillary effect. The racks are equipped with patented designs that not only allow parts to be loaded and unloaded by robots but also multiple racks to be stacked on pallets with a single gripper arm. The tech-rack custom⁺ can be used throughout the entire in-house logistics chain – from cleaning and transport through to storage.



Comp 21/22 material
(see page 5)



Component-specific gridded base available

The base grid can be custom-built for larger order volumes. Components can then be positioned without pins or dividers.



Complete automation: Loading and unloading by robot

The patented design with a small recess allows fully automated robot handling. See page 14.



Customised expansion with Rotary extender

To ensure stackability at any height, rotary extenders can be positioned at different heights in the corners.

Easy assembly thanks to rotary extender

Example of assembly with 96 mm rotary extender, frame and cover

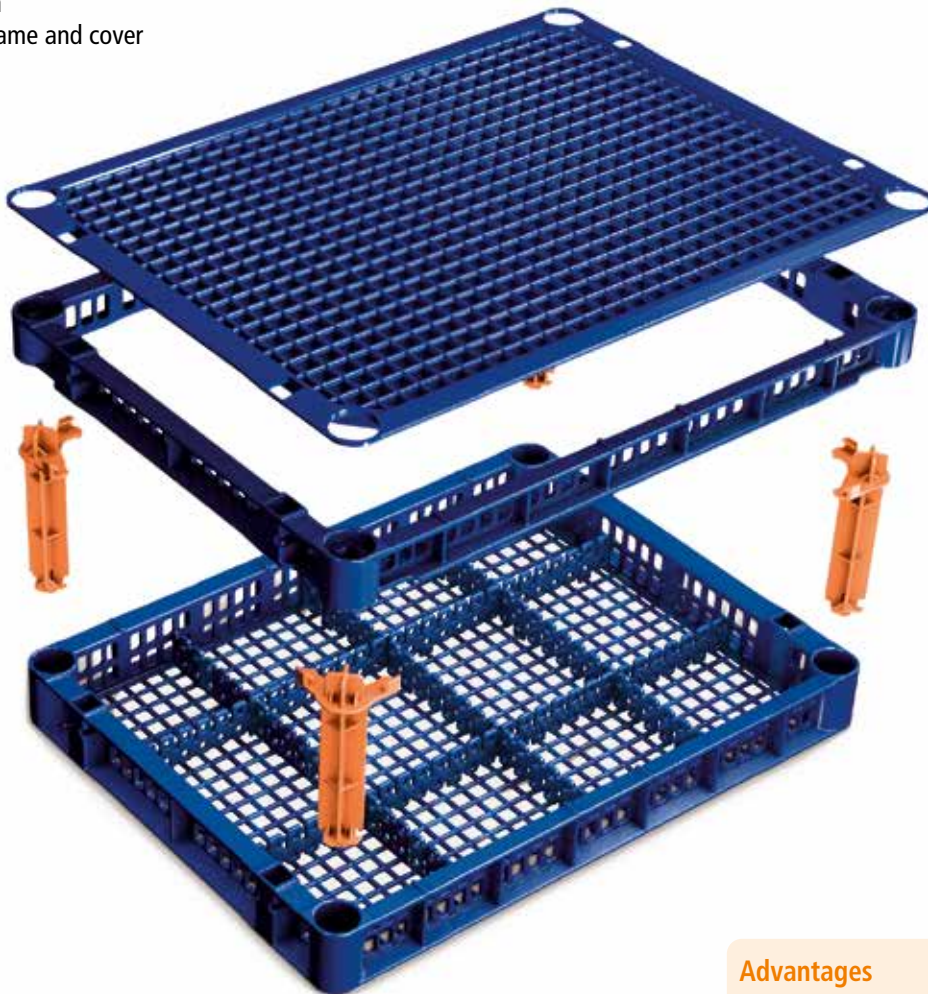

Optimised component protection

Rotating and plug-in pins, as well as dividers, can be placed in the standard grid base for the precise positioning of components.



Optionally with recessed grip

For easier handling, the tech-rack custom⁺ cleaning rack is also available on request with recessed grips.



Advantages

- » Designed for complete automation
- » Component-related grid base available (components can be positioned without any pins or dividers)
- » Automated loading, unloading and stacking thanks to gripper arms
- » The capillary effect is countered by an angled stacking edge and built-in dividers in the base.
- » Optionally available with recessed grips
- » High load capacity
- » RFID chip available on request
- » Rounded corners offer protection against damage

tech-rack custom⁺ cleaning rack

"Versatile all-rounder for customised use"

The tech-rack custom⁺ industrial rack ensures maximum product protection as well as safeguarding from damage and harm to sensitive surfaces during every step throughout the production process

Use of pins and dividers to provide optimum component protection



Rotating and plug-in pins, as well as dividers, can be placed in the standard grid base for the precise positioning of components.

Angled stacking edge prevents the capillary effect

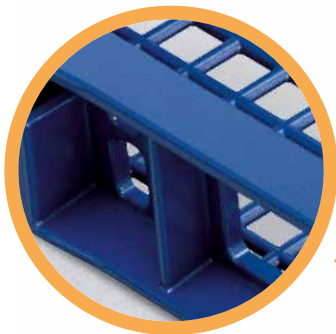

The angled stacking edges with stacking studs prevent liquids from migrating to the components and damaging them due to the capillary effect.

Rack heights can be extended as needed via rotary extenders



To ensure stackability at any height, rotary extenders can be positioned at different heights in the corners.

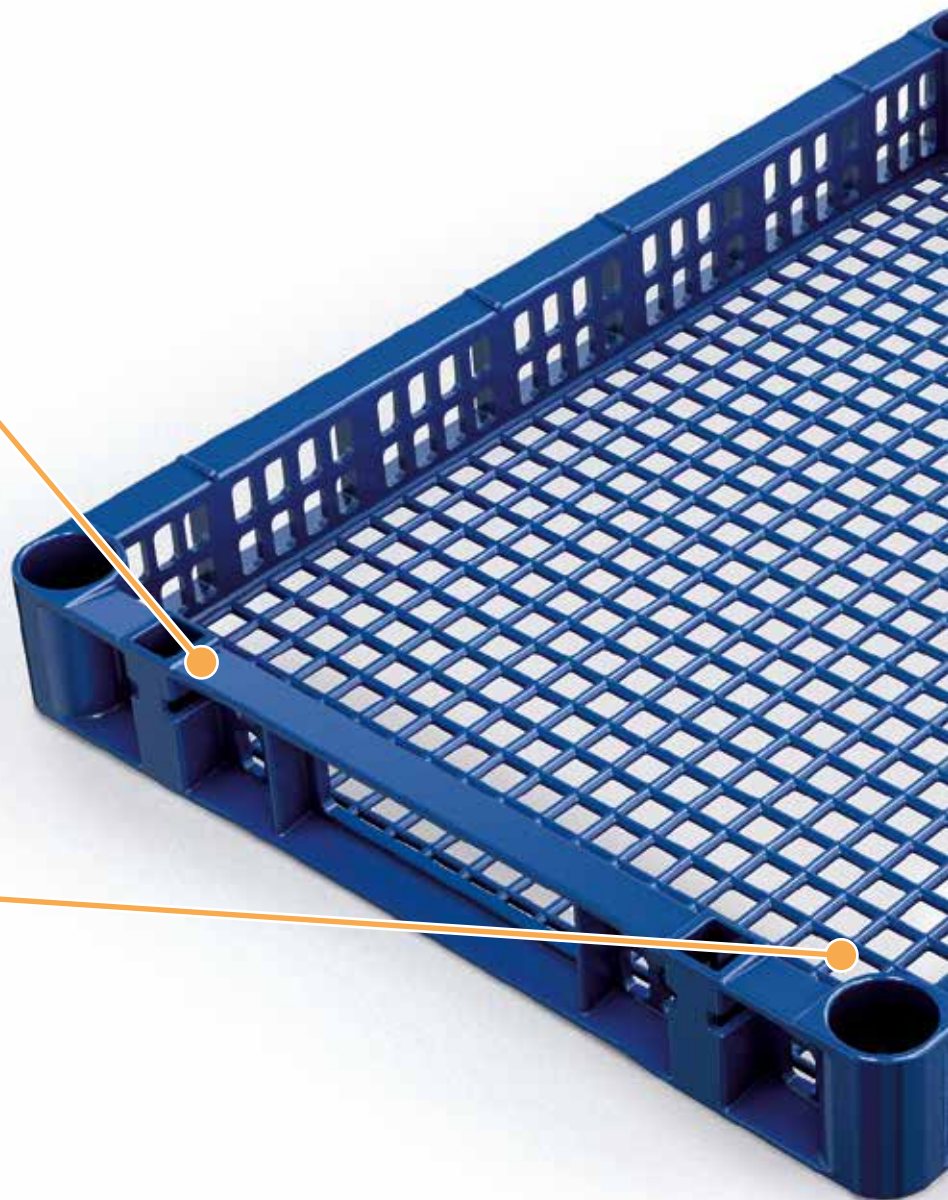

Complete automation: Loading and unloading by robot

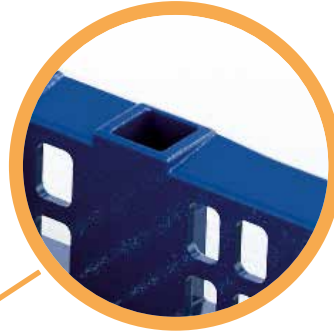

The patented design with a small recess allows fully automated robot handling.

Optionally with recessed grip for easier handling

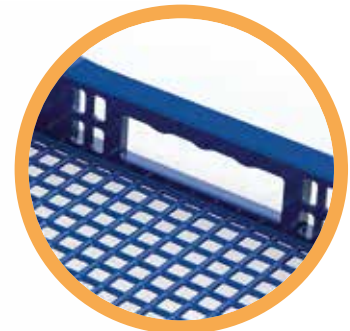

For easier handling, the tech-rack custom* cleaning rack is also available on request with recessed grips.

Component-specific grid base

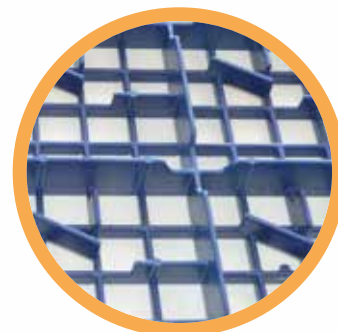

The base grid can be custom-built for larger order volumes. Components can then be positioned without pins or dividers.

The system components: Comp 21/22 material

The Comp 21/22 material offers even higher chemical and thermal resistance and is therefore suitable for more exacting demands in industrial parts cleaning

tech-rack custom⁺ cleaning rack

400 x 300 mm
External height 50 mm / clear internal height 30 mm



Standard rack with variogrid gridded base (Figure) – the grid base can be custom-built for larger order volumes.

tech-rack custom⁺ frame for base rack

400 x 300 mm, height 30 mm
Can be combined with the tech-rack custom⁺

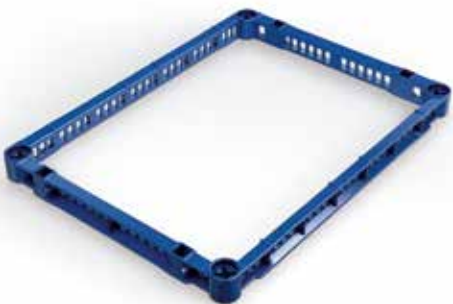

tech-rack custom⁺ cover for base rack

400 x 300 mm, height 13 mm
Can be combined with the tech-rack custom⁺



Dividers

allow compartments matching the size of the workpieces
Available in heights of 28, 42, 69 and 96 mm



Lengths: 257 mm / 361 mm



Lengths: 257 mm / 361 mm

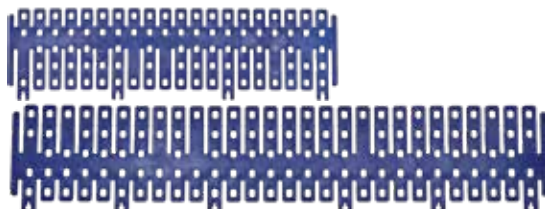

Lengths: 257 mm / 361 mm

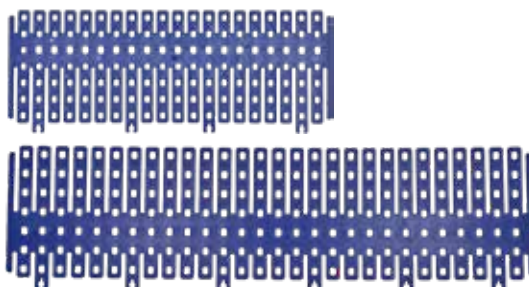

Lengths: 257 mm / 361 mm

The system components: Accessories

Rotary extender

The rotary extenders can be positioned in the corners to ensure stackability at any height.

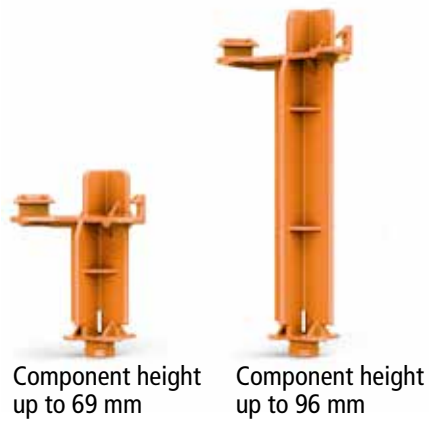

Easy assembly

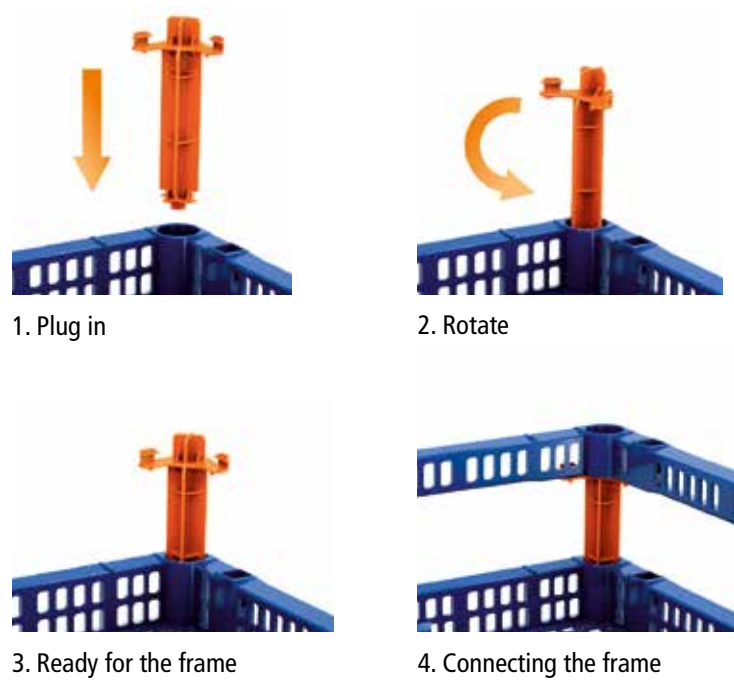

Press-fit bases

The press-fit bases can be driven into the variogrid base plate. This allows a variety of fastening options for hooks, bolts, handles and much more.



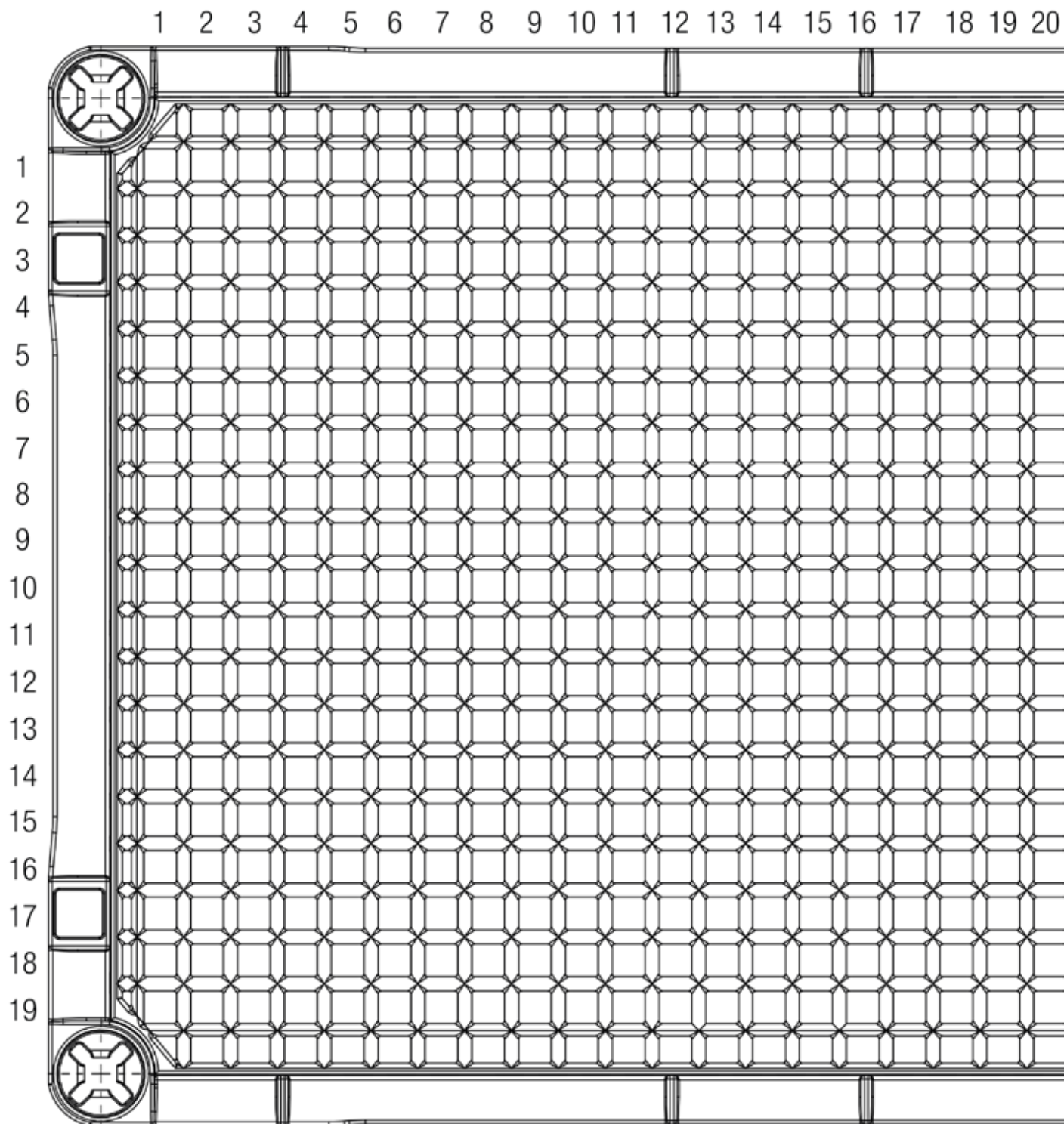

Dimensions in mm, tolerance +/- 1.5 mm

21 22 23 24 25 26 27

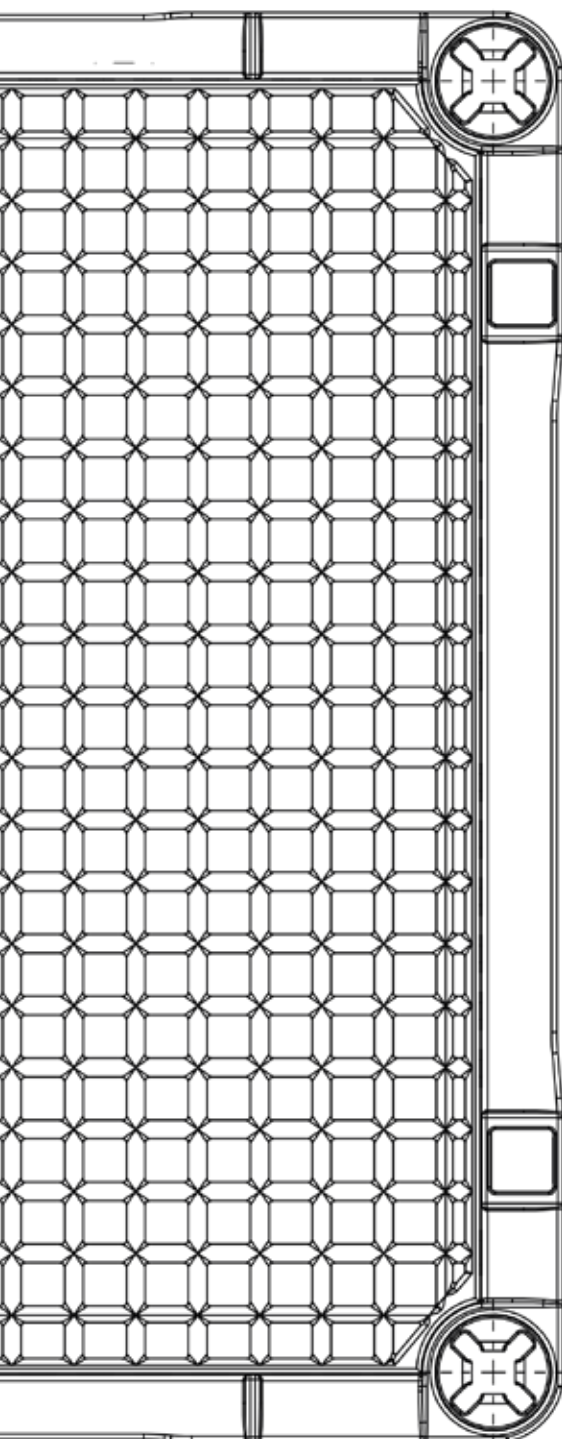

TECH-RACK CUSTOM CLEANING RACK 600 X 400

INDUSTRY 4.0 Developed for automated production processes



tech-rack custom 4.0 cleaning rack

"tech-rack custom – ideal for automated production in industry.
The powerful cleaning rack from FRIES for logistics, cleaning and storage."

The tech-rack custom cleaning rack has been adapted to the new industrial requirements of fully automated production. High-quality metal parts or sensitive workpieces are rinsed thoroughly and gently during the cleaning process, while the angled stacking edges and stacking studs prevent the capillary effect. The racks are designed with patented corner constructions that not only allow parts to be loaded and unloaded by robots but also multiple racks to be stacked on pallets with a single gripper arm. The tech-rack custom can be used throughout the entire in-house logistics chain – from cleaning and transport through to storage.

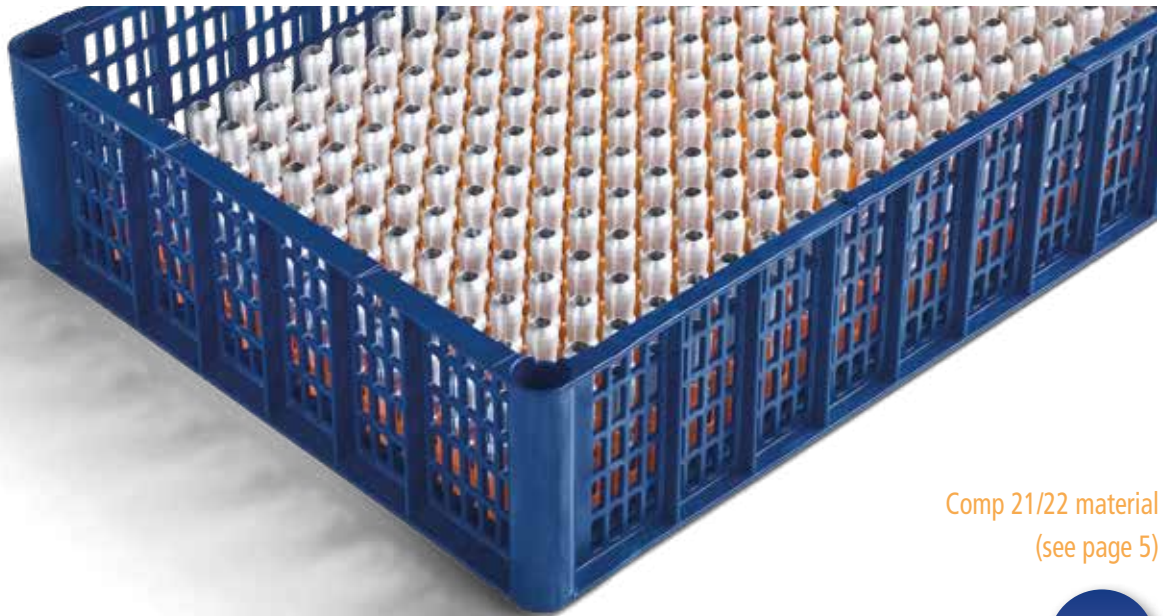

Comp 21/22 material
(see page 5)



Component-specific gridded base available

The base grid can be custom-built for larger order volumes. Components can then be positioned without pins or dividers.

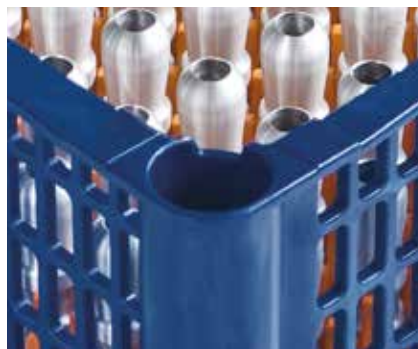

Complete automation: Loading and unloading by robot

The patented corner design with the small recess allows fully automated robot handling.



Angled stacking edge prevents the capillary effect

The angled stacking edges with stacking studs prevent liquids from migrating to the components and damaging them due to the capillary effect.

Automation on the rise

The tech-rack custom cleaning racks can be loaded and unloaded in fully automated production environments and multiple racks can be stacked on pallets using a single gripper arm.

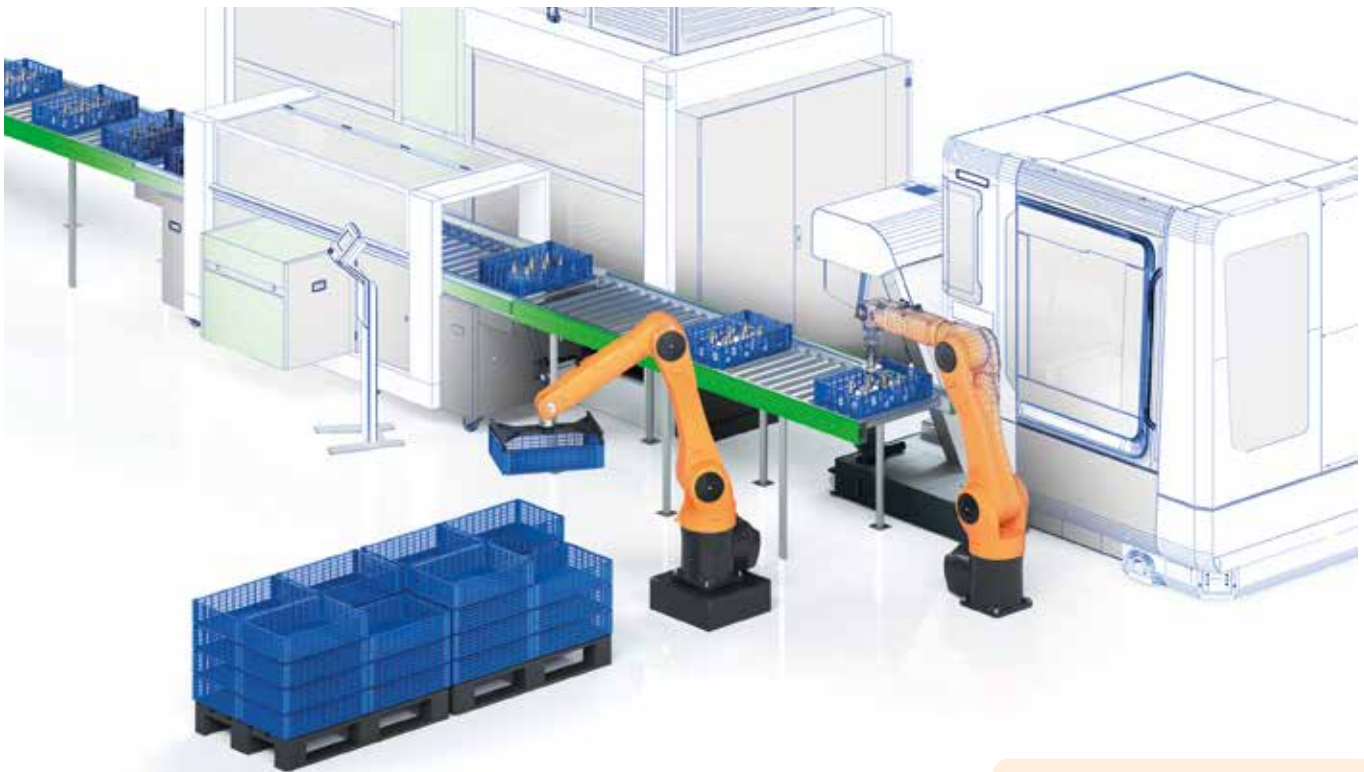

Optimised component protection

Rotating and plug-in pins, as well as dividers, can be placed in the standard grid plate for the precise positioning of components.

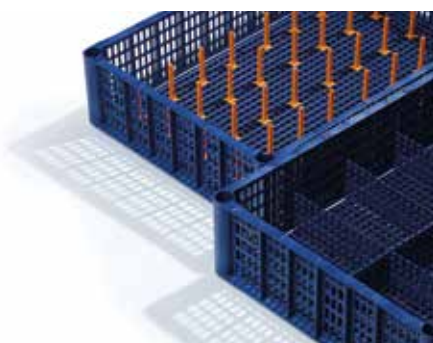

Efficient cleaning

The tech-rack custom cleaning rack can also be stacked in the compartment rack.

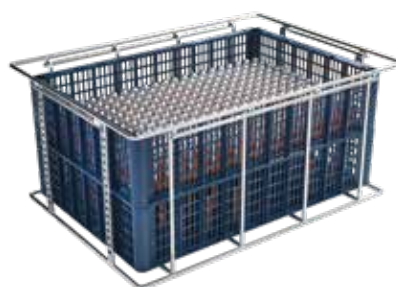

Other advantages:

- » Rounded corners offer protection against damage and harm to sensitive surfaces
- » Dividers are fixed into the base plate, counteracting the capillary effect
- » Rotating pin for holding components can be positioned anywhere
- » A wealth of different configuration options ensures maximum possibilities for component holding
- » Stacking via the gripper arm is possible
- » RFID chip available on request

tech-rack custom 4.0 cleaning rack

"All-rounder for individual applications"

The tech-rack custom cleaning rack impresses with its versatility. Thanks to an array of features, it can adapt perfectly to customer-specific requirements and optimised component protection is guaranteed.

**Complete automation:
Loading and unloading
by robot**



The patented corner design with a small recess allows fully automated robot handling.

**Angled stacking edge
prevents the capillary
effect**



The angled stacking edges with stacking studs prevent liquids from migrating to the components and damaging them due to the capillary effect.

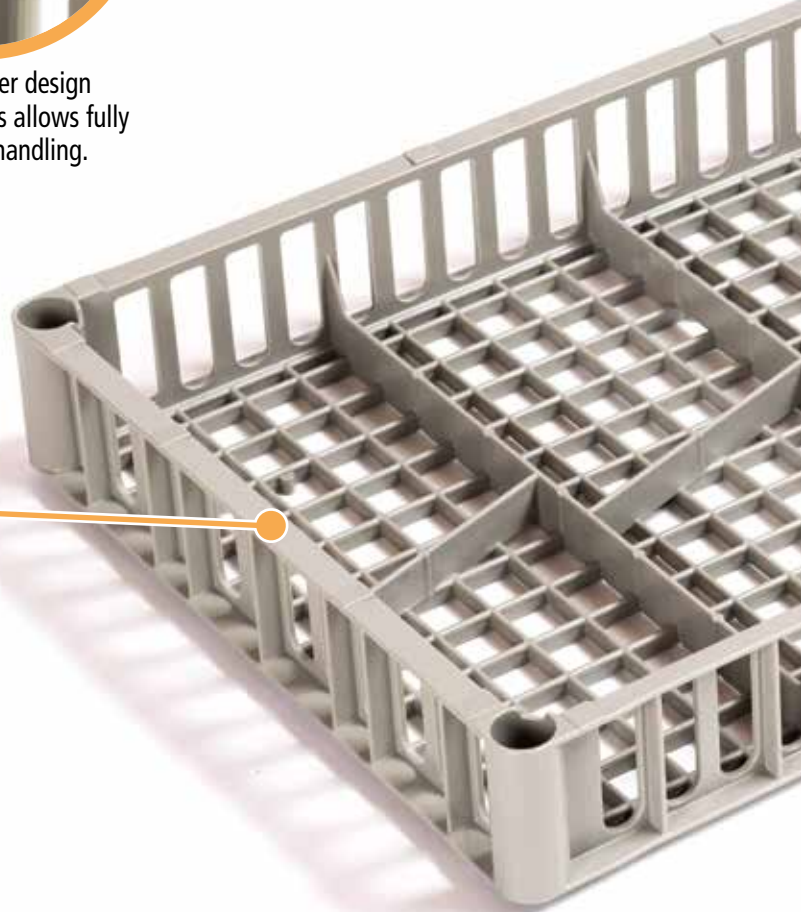



**Angled edges
top and bottom**

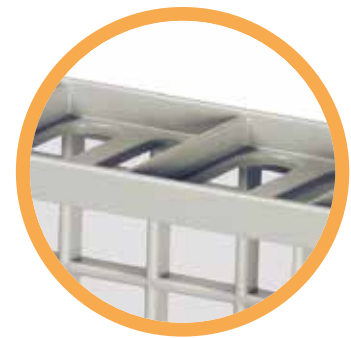

The patented corner design with a small recess allows fully automated robot handling.

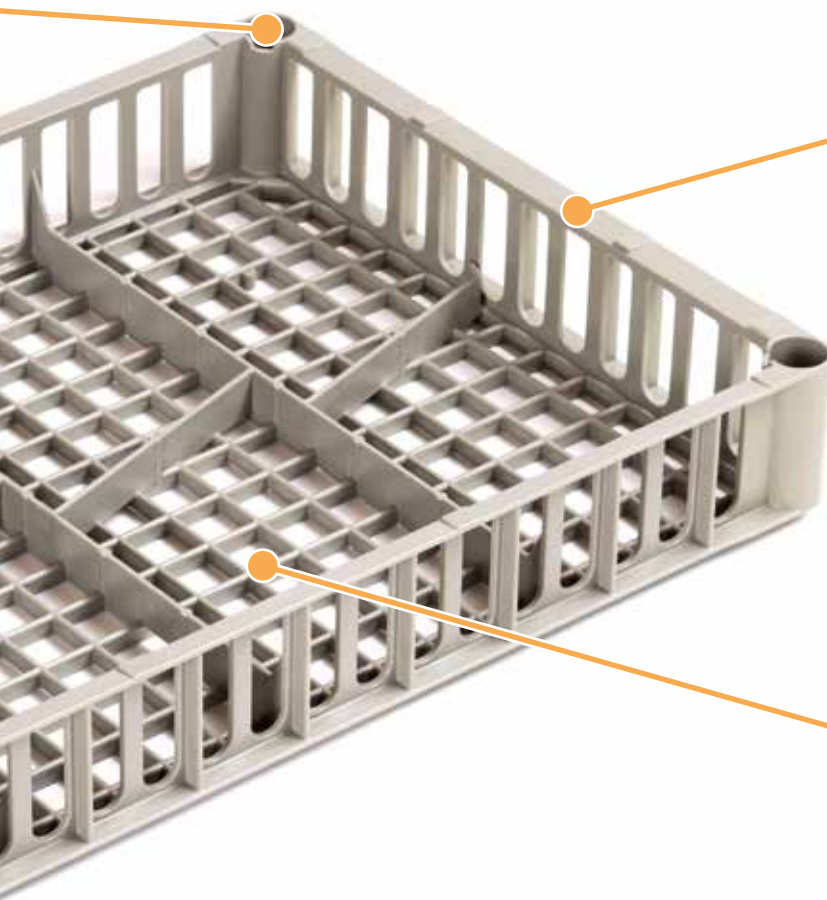

**Component-specific
grid base**

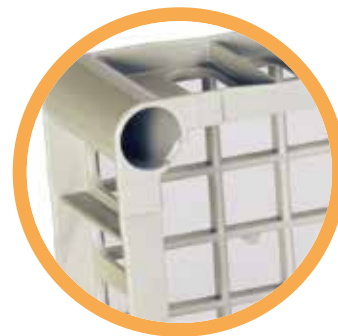

The base grid can be custom-built for larger order volumes. Components can then be positioned without pins or dividers.

References

ALUMINIUM PROCESSOR (A)

The tech-rack custom cleaning rack satisfies the exacting demands of this aluminium-processing company in Austria. The cleaning racks are used in the automated feeder for the cleaning system. Once there, the components are rinsed thoroughly, ensuring clean and residue-free surfaces. The tech-rack cleaning rack is used throughout the internal and external logistics chain.





The system components: Comp 21/22 material

The Comp 21/22 material offers even higher chemical and thermal resistance and is therefore suitable for more exacting demands in industrial parts cleaning

tech-rack custom cleaning rack

600 x 400 mm
External height 138.5 mm / clear internal height 119.5mm



Standard rack with variogrid gridded base (Figure) – the gridded base can be custom-built for larger order volumes.

tech-rack cover for base rack

600 x 400 mm, height 13 mm,
can be combined with the tech-rack variogrid, tech-rack



Dividers

allow compartments matching the size of the workpieces
Available in heights of 28, 42, 69 and 96 mm



Lengths: 361 mm / 558 mm



Lengths: 361 mm / 558 mm

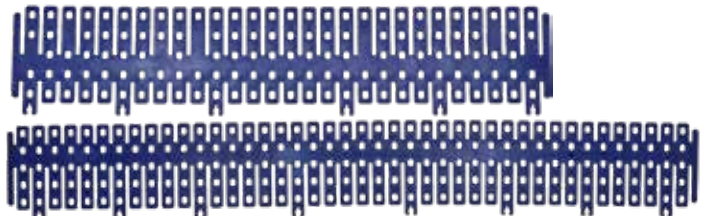

Lengths: 361 mm / 558 mm

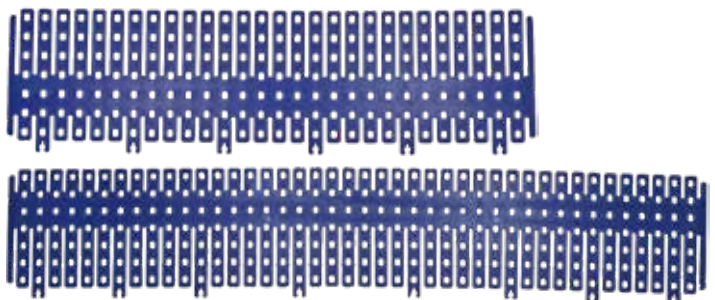

Lengths: 361 mm / 558 mm

The system components: Accessories

Press-fit bases

The press-fit bases can be driven into the variogrid base plate. This allows a variety of fastening options for hooks, bolts, handles and much more.



With thread



Without thread



1. Hammering



2. Ready for further assembly

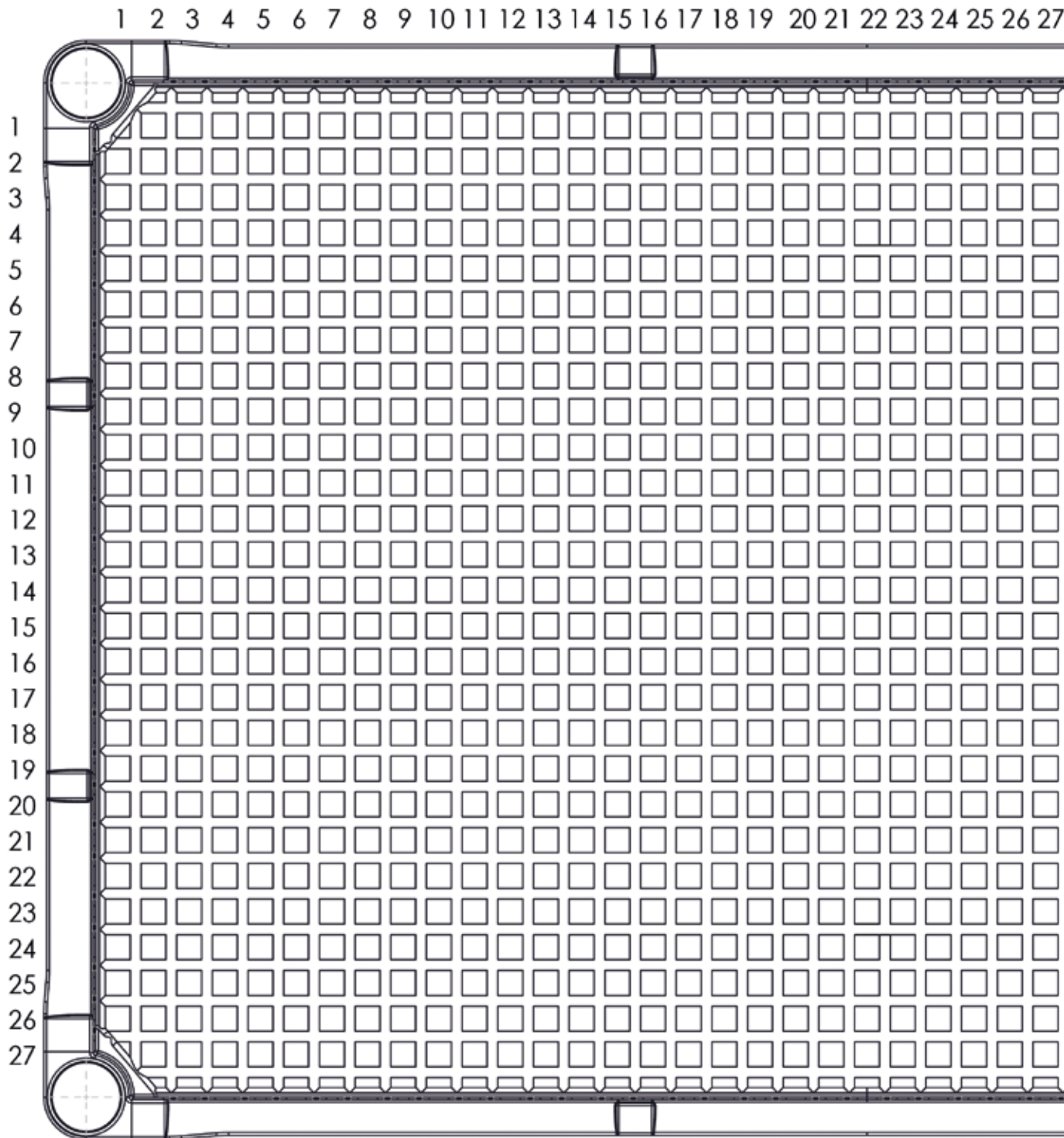

Dimensions in mm, tolerance +/- 1.5 mm

28 29 30 31 32 33 34 35 36 37 38 39 40 41 42 43

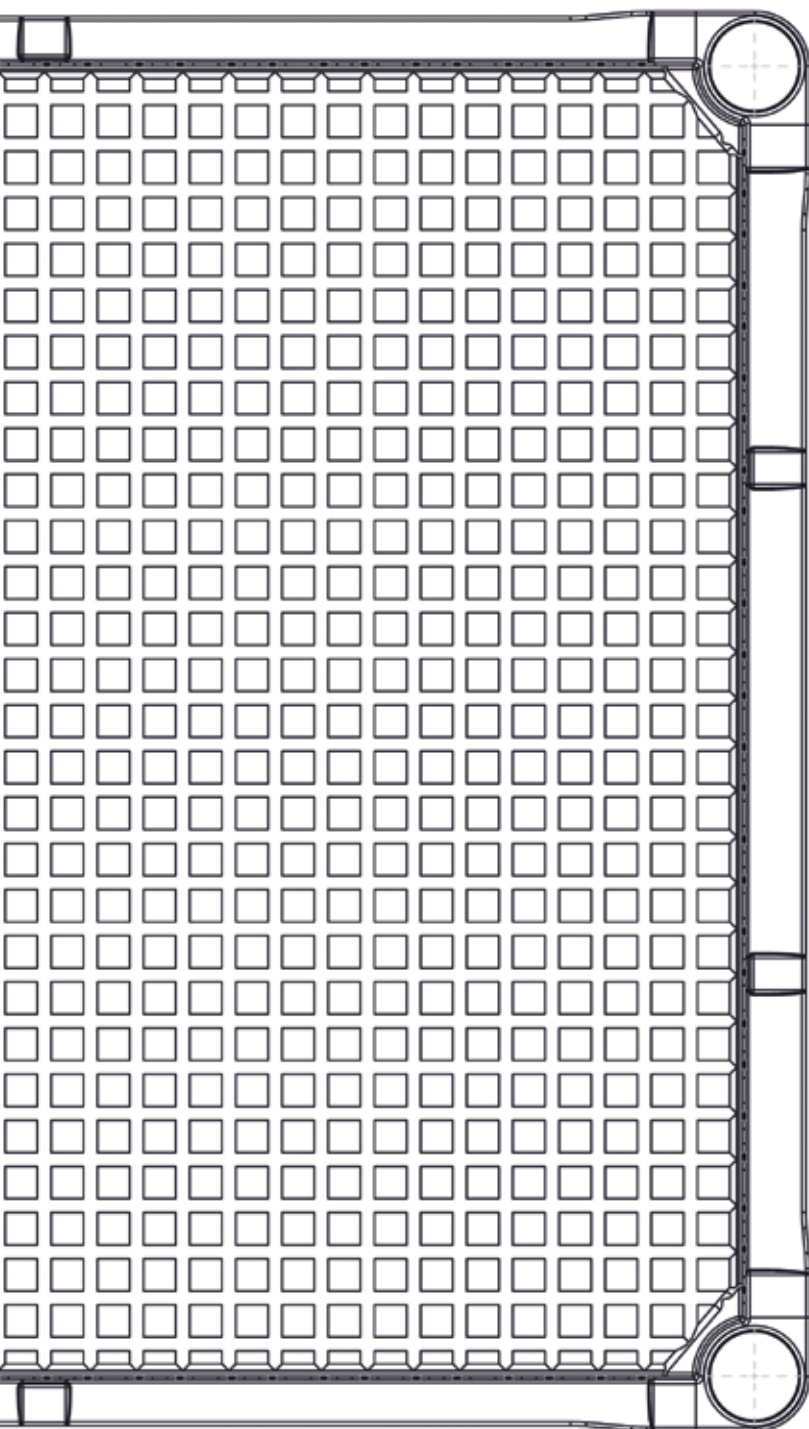

TECH-RACK CLEANING RACK 600 X 400

THE ADAPTABLE SOLUTION Customised height modifications;
can be adjusted for use with other compartment dimensions



tech-rack cleaning rack

"tech-rack 600 x 400 – the efficient all-in-one system for industry.
The adaptable cleaning rack from FRIES for logistics, cleaning and storage."

Workpieces are also valuable. When it comes to construction components for technical industries, maximum quality and safety are paramount. This is especially true in the case of complex production processes – from blanks to precision construction and finished parts.

The FRIES tech-rack cleaning rack ensures efficiency and operating comfort at each process stage: optimised cleaning results, superlative protection for sensitive surfaces, damage-free transport and perfect storage. The industrial rack is available in Comp 13/14 and Comp 21/22 material versions, depending on the application.



Materials depending on requirements:

(see page 5)



Comp 13/14



Comp 21/22



Modular structure

The cleaning rack can be adapted perfectly to the components or the customer's requirements and quickly switched to accommodate other compartment dimensions and heights.



Efficient cleaning

Excellent cleaning results and superb component cleanliness are achieved thanks to optimised openings in the cleaning rack.

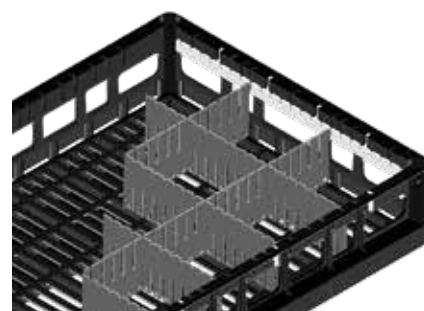

Flexible and easy compartment adjustment with dividers

Millimetre-accurate height adjustment and a 15-mm grid on the longitudinal and lateral side offer the best possible use of space and excellent protection for components.

Custom configuration thanks to tube or Clix extenders

The tech-rack cleaning rack is made up of numerous individual components and can be customised in line with different component requirements or customer needs in terms of both the height and size of partitions.

The base rack can be loaded with workpieces up to a height of 72 mm and will still remain stackable. With end frames, the rack can be produced with a clear internal height starting from 135 mm.

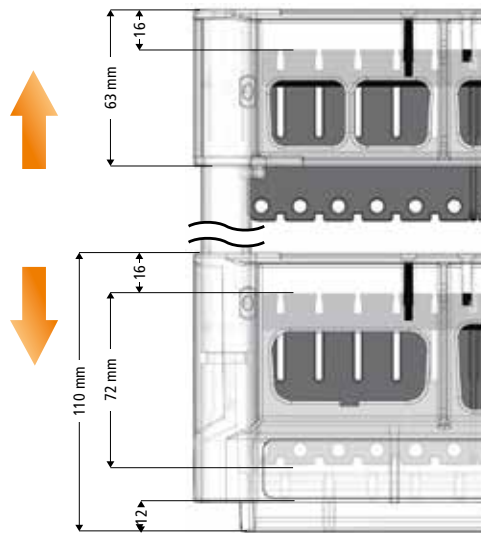

Custom rack version

for customised heights

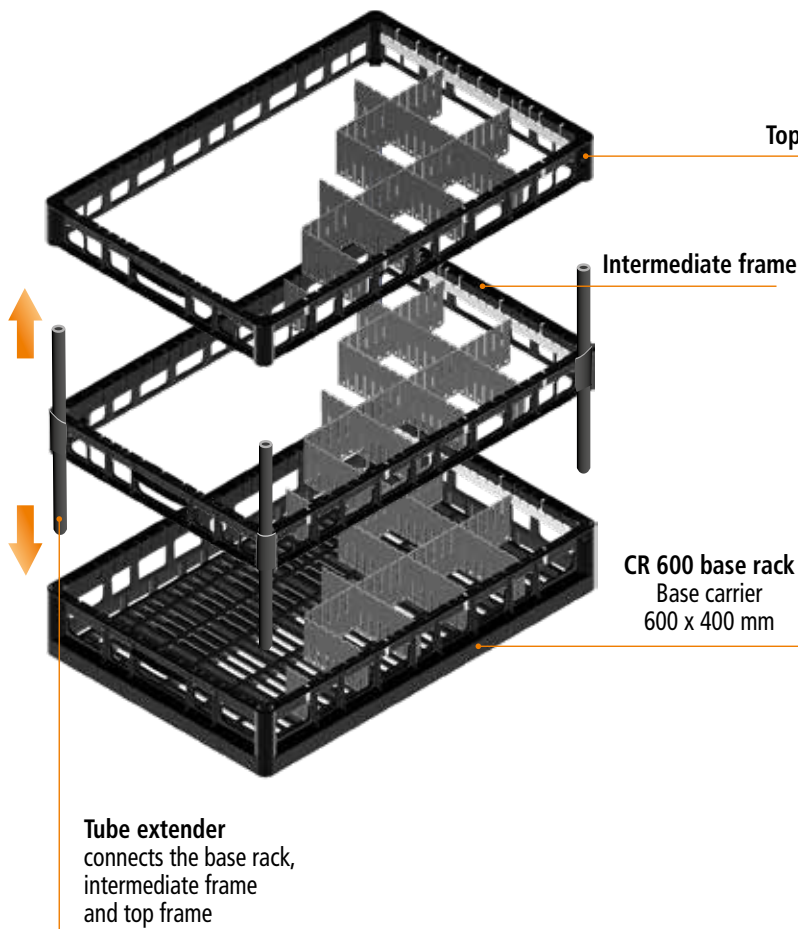

Clixrack version

for standard heights in 15-mm increments

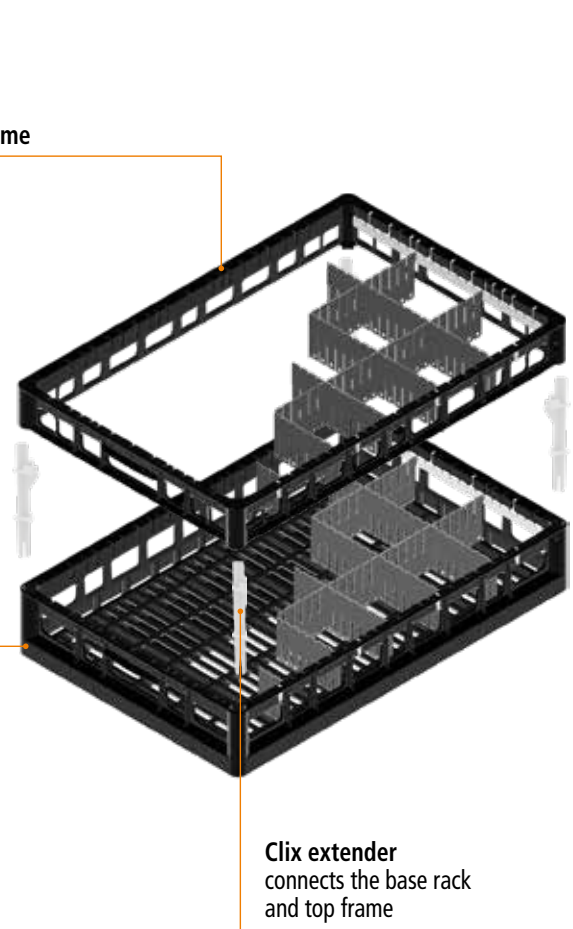

References

HAAG-STREIT AG, Koeniz (CH)

The tech-rack cleaning rack is used for larger component geometries. The high flexibility, excellent accessibility of the cleaning medium and the low intrinsic weight of the cleaning rack mean that Haag-Streit benefits from the simple and safe handling of their components.



BOERS & CO FIJNMETAAL GROUP, Schiedam (NL)

More than 2,500 tech-rack cleaning racks are in use at Boers. They are cleaned using modified alcohols. The racks are used for transport, cleaning and storage.





Haag-Streit AG, Koeniz (CH)

Stefan Oetliker



"At our facility, all FRIES systems – that is tech-rack variogrid, techtray and the tech-rack – are used in combination, depending on the component and requirements."



Boers & Co FijnMetaal Group, Schiedam (NL)

Ronald Koot



"Our high-quality precision-engineering parts that are made from various materials can be safely cleaned and transported using the tech-rack systems."

Range of configuration options

"Customised, fast, safe assembly without tools"

Base rack with side strip (open)

Longitudinal and lateral dividers in height 70 mm



External rack height: 110 mm (stacked 100 mm)

Extender	Component height up to	Rack outer dimensions	Rack type*
without	72 mm	110 mm	PAA

* Rack complete without cross and longitudinal dividers

Base rack with side wall (closed)

Longitudinal and lateral dividers in height 34 mm



Longitudinal and lateral dividers in height 70 mm



Extender	Component height up to	Rack outer dimensions	Rack type*
without	72 mm	110 mm	PAB

* Rack complete without cross and longitudinal dividers

Base rack and top frame with side strip (open)

Longitudinal and lateral dividers in height of 70 mm (base rack) and height of 70 mm (top frame)



Extender	Component height up to	Rack outer dimensions	Rack type*
155	155 mm	200 mm	PAC/155
170	170 mm	215 mm	PAC/170
185	185 mm	230 mm	PAC/185
200	200 mm	245 mm	PAC/200
215	215 mm	260 mm	PAC/215
230	230 mm	275 mm	PAC/230
Tube	customised in mm	customised in mm	PARC/...

* Rack complete without cross and longitudinal dividers

Base rack and top frame with side walls (closed)

Longitudinal and lateral dividers in height of 70 mm (base rack) and height of 70 mm (top frame)



Longitudinal and lateral dividers in height of 70 mm (base rack) and height of 34 mm (top frame)



Extender	Component height up to	Rack outer dimensions	Rack type*
155	155 mm	200 mm	PAD/155
170	170 mm	215 mm	PAD/170
185	185 mm	230 mm	PAD/185
200	200 mm	245 mm	PAD/200
215	215 mm	260 mm	PAD/215
230	230 mm	275 mm	PAD/230
Tube	customised in mm	customised in mm	PARD/...

* Rack complete without cross and longitudinal dividers

Base rack with side strip (open) and top frame with side wall (closed)

Longitudinal and lateral dividers in height of 70 mm (base rack) and height of 34 mm (top frame)



Extender	Component height up to	Rack outer dimensions	Rack type*
155	155 mm	200 mm	PAE/155
170	170 mm	215 mm	PAE/170
185	185 mm	230 mm	PAE/185
200	200 mm	245 mm	PAE/200
215	215 mm	260 mm	PAE/215
230	230 mm	275 mm	PAE/230
Tube	customised in mm	customised in mm	PARE/...

* Rack complete without cross and longitudinal dividers

Sizes
400 x 300,
400 x 400 and
500 x 500 on
request!

The Comp 13/14 material system components

The Comp 13/14 material was designed for the basic needs of industrial component production and is suitable for cleaning processes involving aqueous and solvent-based media, as well as for ultrasound applications.

tech-rack base rack

600 x 400 mm, external rack height 110 mm, can be used with side strip (open) or side wall (closed)



tech-rack cover for base rack

600 x 400 mm, height 13 mm
Can be combined with the tech-rack variogrid



Intermediate frame

600 x 400 mm, height 63 mm,
for custom rack or Clixrack



Side strip

for fixing dividers
GS 15 high



Side wall

for fixing dividers
GS 15 high and low

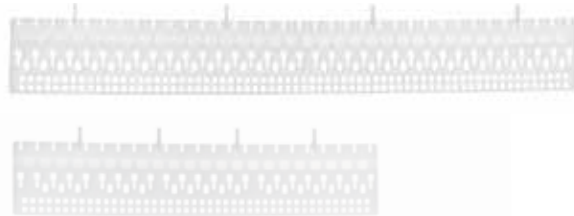

Low top frame

600 x 400 mm, height 36 mm,
for custom rack or Clixrack
Can be combined with tech-rack variogrid



Lateral and longitudinal dividers high

GS 15 high
Grid size 15 mm, height 70 mm

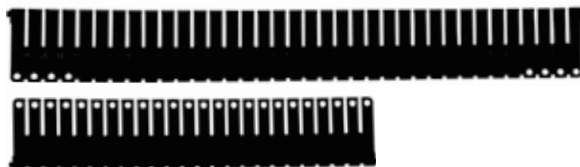

Lateral and longitudinal dividers low

GS 15 low
Grid size 15 mm, height 34 mm

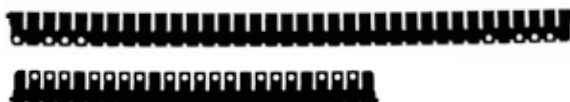

Tall top frame

600 x 400 mm, height 63 mm,
for custom rack or Clixrack; can be combined with the tech-rack variogrid



The system components: Comp 21/22 material

The Comp 21/22 material offers even higher chemical and thermal resistance and is therefore suitable for more exacting demands in industrial parts cleaning

tech-rack base rack

600 x 400 mm, external rack height 110 mm, can be used with side strip (open) or side wall (closed)



tech-rack cover for base rack

600 x 400 mm, height 13 mm, can be combined with the tech-rack variogrid, tech-rack custom



Intermediate frame

600 x 400 mm, height 63 mm, for custom rack or Clixrack



Side strip

for fixing dividers
GS 15 high



Side wall

for fixing dividers
GS 15 high and low

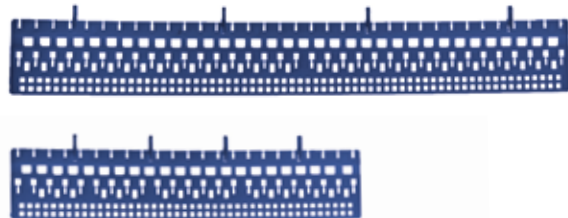

Low top frame

600 x 400 mm, height 36 mm, for custom rack or Clixrack, can be combined with tech-rack variogrid



Lateral and longitudinal dividers high

GS 15 high
Grid size 15 mm, height 70 mm

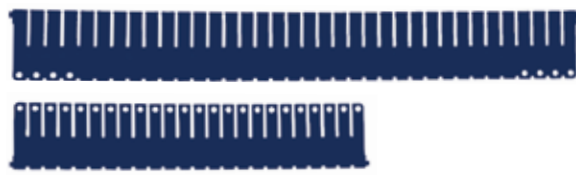

Tall top frame

600 x 400 mm, height 63 mm, for custom rack or Clixrack; can be combined with the tech-rack variogrid



Lateral and longitudinal dividers low

GS 15 low
Grid size 15 mm, height 34 mm



The system components: Accessories

Tube extender for custom rack

connects the base rack, intermediate frame and top frame. Tube can be adapted to the component height as required.



Extender for Clixrack

connects the base rack, intermediate frame and top frame made from PA.



Extender	Component height up to
145	145 mm
155	155 mm
170	170 mm
185	185 mm
200	200 mm
215	215 mm
230	230 mm
245	245 mm

Clixrack dismantling tool

for easy dismantling of Clix extenders



Extender for Clixrack

connects the base rack, intermediate frame and top frame in Comp 21/ 22.



Extender	Component height up to
145	145 mm
155	155 mm
170	170 mm
185	185 mm
200	200 mm
215	215 mm
230	230 mm
245	245 mm

Base grid for small parts

optional for small workpieces and bulky goods
Mesh width 3 x 3 mm (fine mesh)





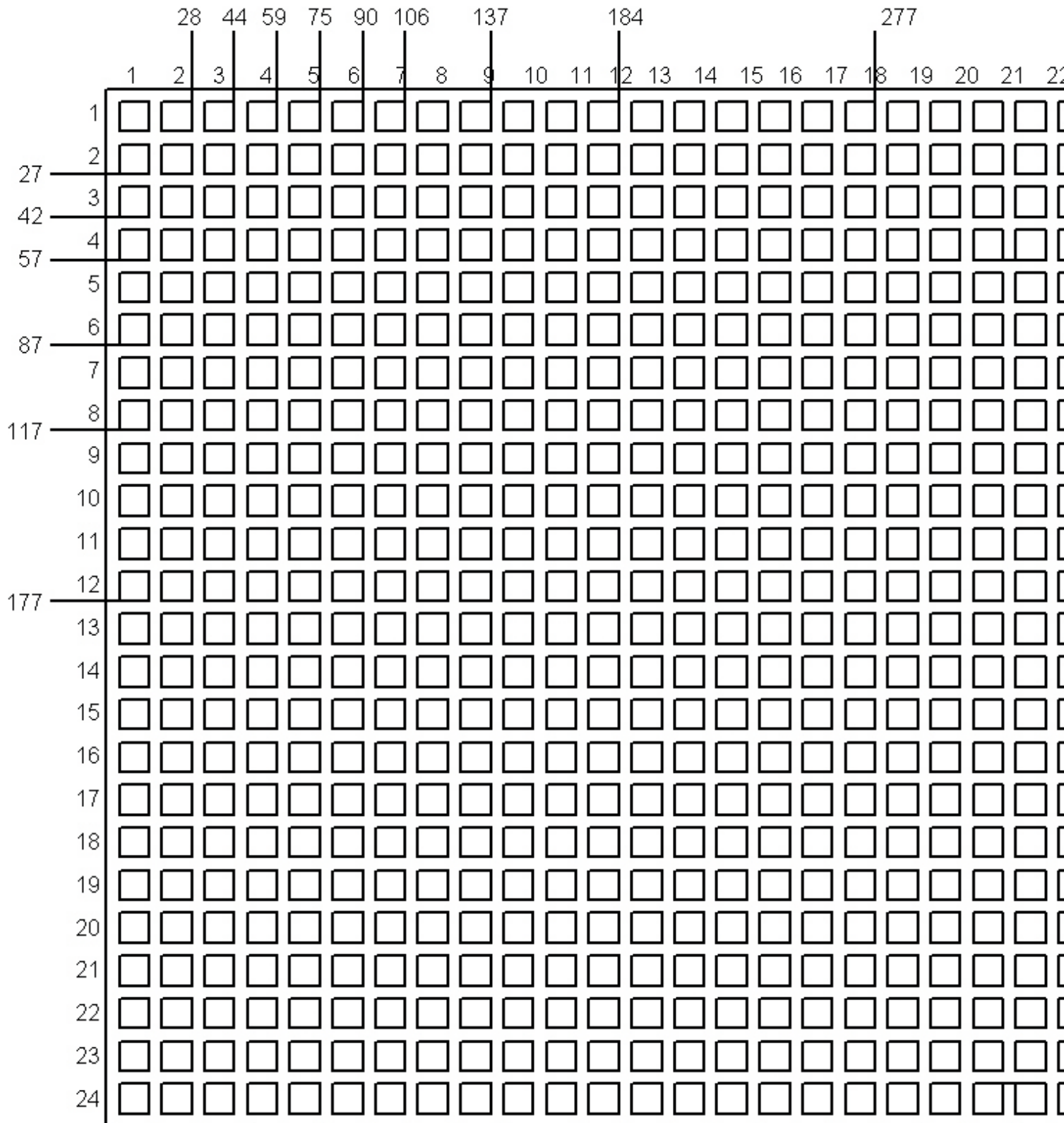

2 23 24 25 26 27 28 29 30 31 32 33 34 35 36

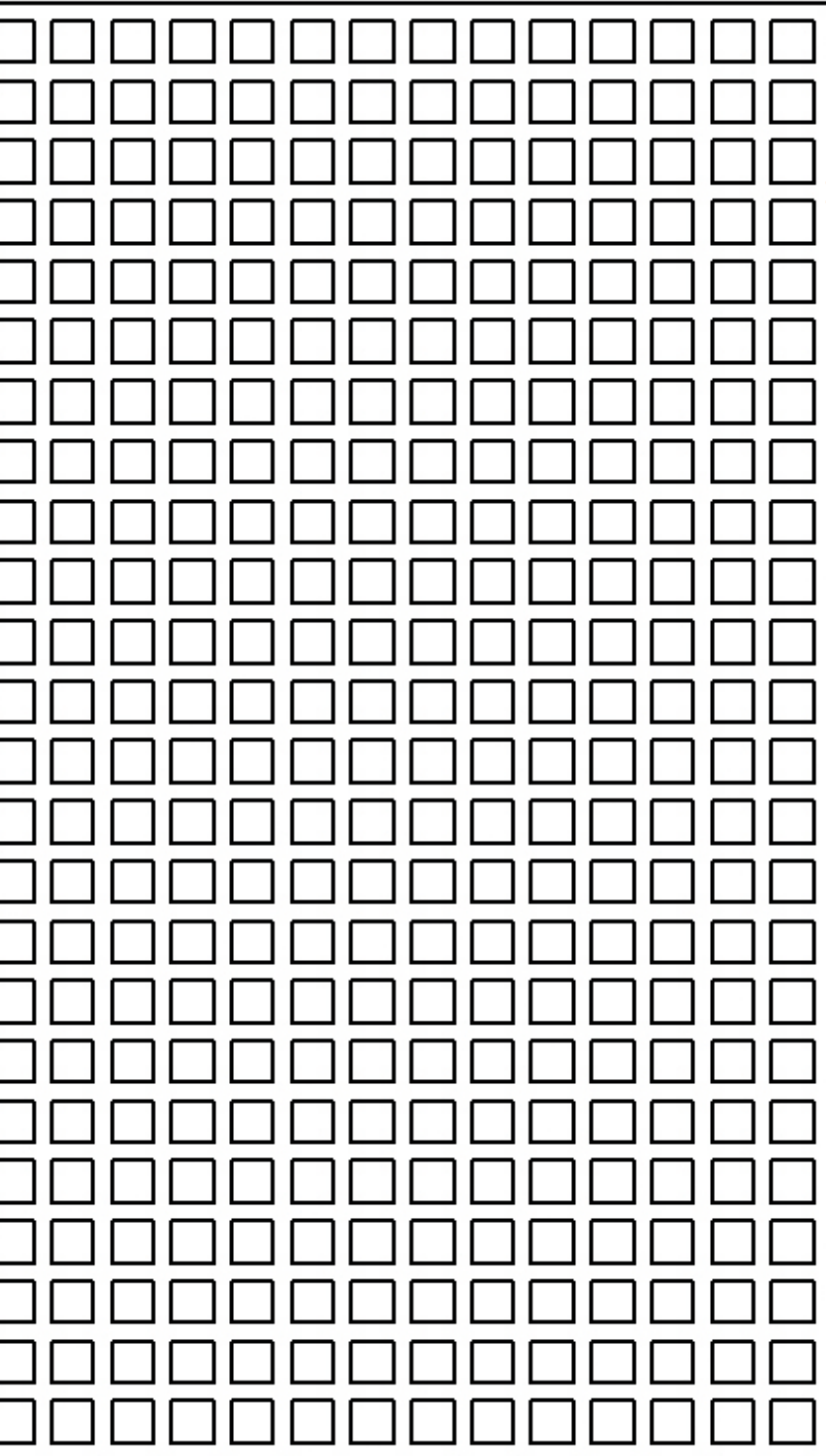

Divider thickness
= 3 mm

Not true to scale, dimensions in mm

Simple and fast assembly

"Customised, sustainable, reliable"

The side strips and walls, as well as the lateral and longitudinal dividers, can be easily assembled without an assembly tool. They can also be dismantled and converted without tools.

Side strip version

or

Side wall version

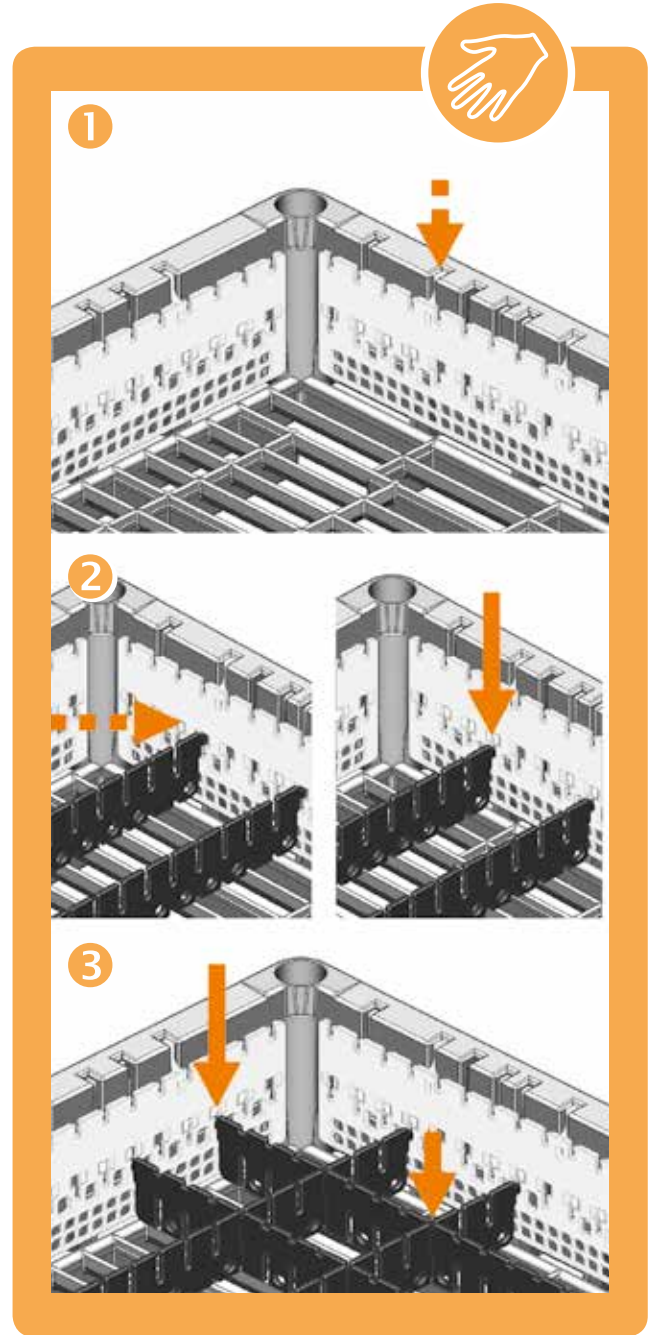
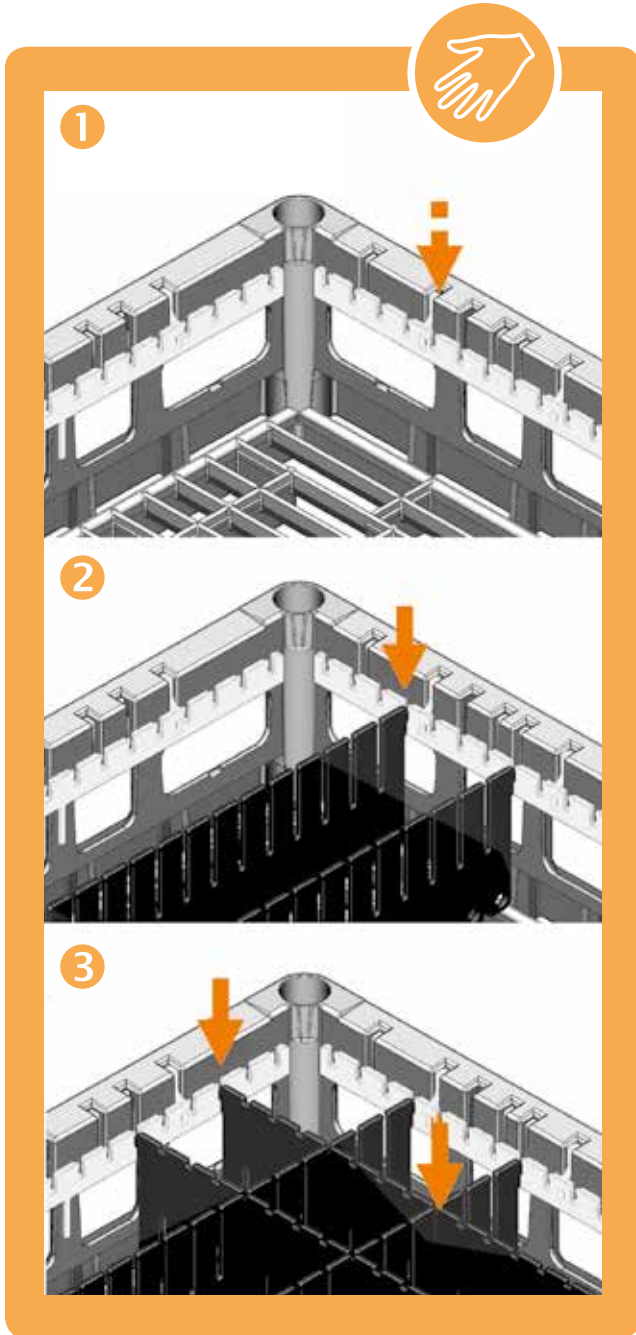

Same assembly process as for the top and intermediate frames.

FRIES Kunststofftechnik

"Quality from Austria"

For generations, FRIES Kunststofftechnik GmbH's core area of expertise has been the development and production of high-quality plastic products. In the area of industrial component cleaning in particular, workpiece carriers and cleaning racks made from plastic offer a wealth of advantages over conventional metal grid racks.

Our careful and efficient methodology and short production times that deliver superlative quality help make your projects a reality: from prototypes and customer-specific developments to series production – and all from a single source. Without exception, all of our products are manufactured at our headquarters in Sulz, Austria.



Workpiece carrier systems All the advantages at a glance

www.fries-kt.com



WORLDSTAR
WINNER 2017



FRIES Kunststofftechnik GmbH

Schützenstrasse 19, 6832 Sulz, Austria
Tel.: +43 5522 4935 201, Fax: +43 5522 4935 209
info@fries.at, www.fries-kt.com



Packaging



Gastro



Industry racks



Moulding